



Xtreme Value Tower Series (XVT)

User's & Installation Manual

TABLE OF CONTENTS

PRODUCT DESCRIPTION	5
UPS Functionality	5
Battery/Surge Outlets	6
Power Switch	6
Power On Indicator	6
Circuit Breaker	6
USB	6
DETERMINING THE POWER REQUIREMENTS OF YOUR EQUIPMENT	7
HARDWARE INSTALLATION GUIDE	7
QUICKSTART SOFTWARE INSTALLATION GUIDE	9
REPLACING THE BATTERY	14
DEFINITIONS FOR LED INDICATORS	15
ALARMS	15
TROUBLESHOOTING	16
SPECIFICATIONS	17
SHIPPING LIST	18
OBTAINING SERVICE	19
XTREME POWER CONVERSION® (XPC) CORPORATION LIMITED WARRANTY	20
XTREME POWER CONVERSION® LOAD PROTECTION POLICY	21

SAFETY INSTRUCTIONS

ATTENTION: To safely interact with and enjoy all the features and benefits of these Xtreme Power Conversion Uninterruptible Power Supplies (UPS), please read and follow all installation and operation instructions completely. These UPS are designed to provide power protection for connected electronic equipment.

Please read this manual before installing the XVT-Series UPS models XVT-600, XVT-800, XVT-1200, and XVT-1500 as it provides important information that should be followed during installation and maintenance of the UPS and batteries, allowing you to correctly set up your system for the maximum safety and performance. Included is information on customer support and factory service, if it is required. If you experience a problem with the UPS, please refer to the Troubleshooting section in this manual to correct the problem. If the problem is not corrected, please collect information so that the Technical Support personnel can more effectively assist you.

CAUTION: Any changes or modifications not expressly approved by the manufacturer of this device could void the user's authority to operate the equipment.

FCC Notice: This equipment has been tested and found to comply with the limits for a Class B Digital Device pursuant to Part 15 of the FCC Rules. These limits are designed to provide reasonable protection against harmful interference in residential installation. This equipment generates uses and can radiate radio frequency energy and, if not installed and used in accordance with the instructions, may cause harmful interference to radio communications. There is no guarantee that interference will not occur in a particular installation. If this equipment does cause harmful interference to radio or television reception, which can be determined by turning the equipment off and on, the user is encouraged to try to correct the interference by one or more of the following measures:

1. Reorient or relocate the receiving antenna.
2. Increase the separation between the equipment and receiver.
3. Connect the equipment into an outlet on a circuit different from that to which the receiver is connected.
4. Consult the dealer or an experienced technician for help. Any special accessories needed for compliance must be specified in the instruction.

CAUTION: A shielded-type power cord is required in order to meet FCC emission limits and to prevent interference to the nearby radio or TV reception. It is essential that only the supplied power cord be used. Use only shielded cables to connect I/O devices to this equipment.

CAUTION: Any changes or modifications not expressly approved by the manufacturer of this device could void the user's authority to operate the equipment.

IMPORTANT SAFETY INSTRUCTIONS:

(SAVE THESE INSTRUCTIONS)

This manual contains important safety instructions. Please read and follow ALL instructions carefully during the installation and operation of the UPS. Read this manual thoroughly before attempting to unpack, install, or operate.

CAUTION! To prevent the risk of fire or electric shock, install in a temperature and humidity controlled indoor area, free of conductive contaminants. (Please see specifications for acceptable temperature and humidity range).

CAUTION! To reduce the risk of electric shock, do not remove the UPS cover. Qualified Service Personnel must perform ALL repairs and maintenance. No user serviceable parts inside.

CAUTION! Hazardous live parts inside can be energized by the battery even when the AC input power is disconnected.

CAUTION! UPS must be connected to an AC power outlet with fuse or circuit breaker protection. Do not plug into an AC wall outlet that is not grounded. If you need to de-energize this equipment, turn off and unplug the UPS.

DO NOT USE FOR MEDICAL OR LIFE SUPPORT EQUIPMENT! Xtreme Power does not sell products for life support or medical applications. DO NOT use these UPS in any circumstances that would affect operation or safety of any life support equipment or with any medical applications or patient care.

NOTICE! Not for use in a computer room as defined in the Standard for Protection of Electronics Computer/Data Processing Equipment.

NOTICE! An acceptable outlet (based upon UPS Specifications) shall be installed near the equipment and shall be easily accessible.

PRODUCT DESCRIPTION

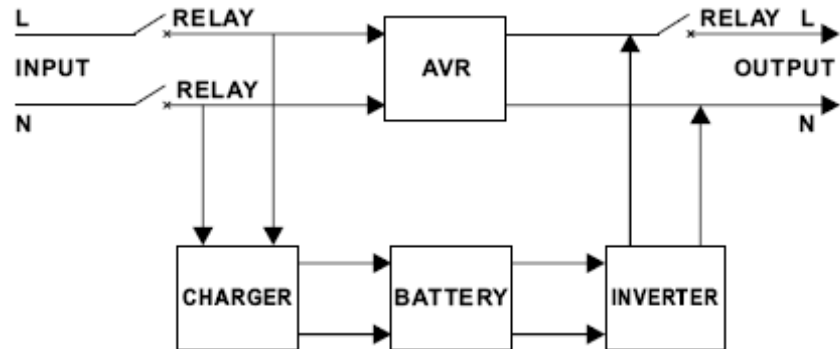

UPS Functionality

The XVT UPS products use Line-Interactive Automatic Voltage Regulation (AVR) UPS technology. Under normal AC power operation, the input power flows through the AVR circuit, regulating the incoming AC power to the output of the UPS and the load connected. If the input power disappears, the Inverter circuit is switched on to provide output from the batteries contained within the UPS.

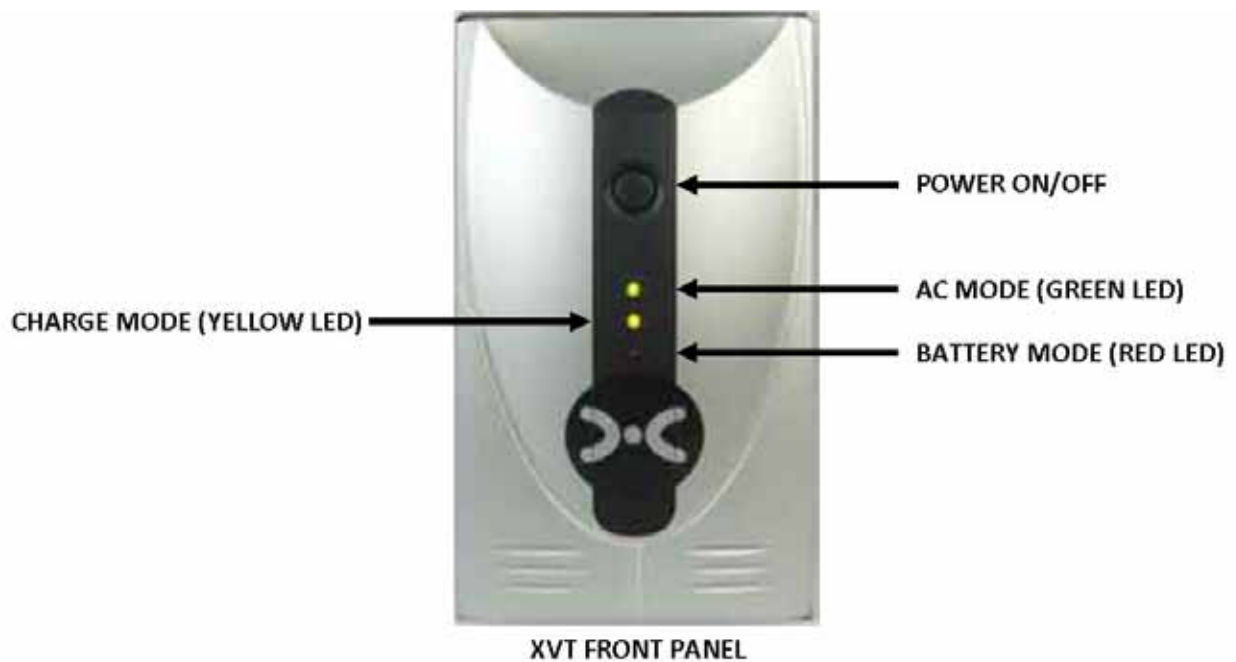

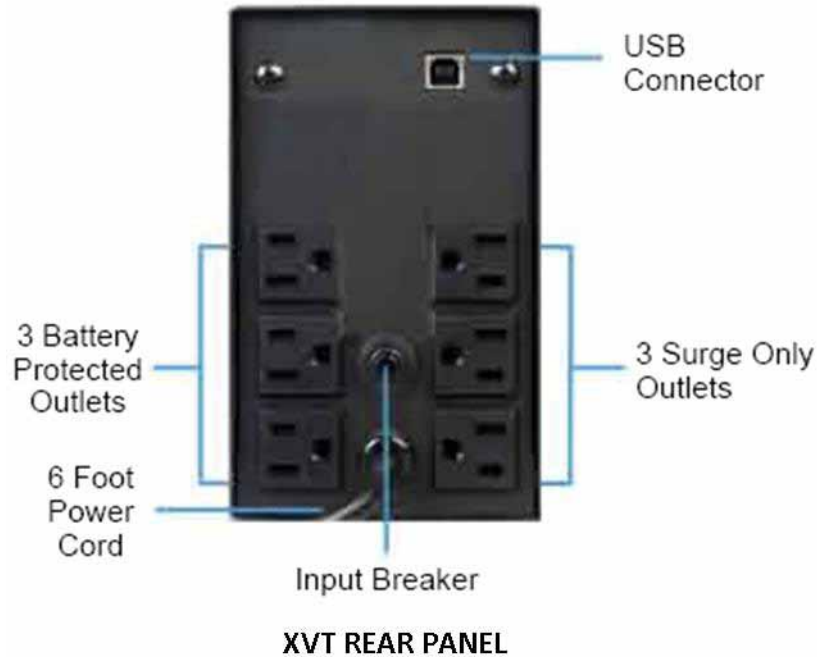

Battery/Surge Outlets

Provides battery-powered/surge outlets for the connected equipment, and insures uninterruptible operation of your equipment during a power failure.

Power Switch

Can be used as a master on/off switch for equipment connected to the battery-powered outlets.

Power On Indicator

This LED is illuminated when the utility condition is normal and the UPS outlets are providing power, free of surges and spikes.

Circuit Breaker

The circuit breaker that provides overload and fault protection.

USB

Port/protocol that provides communication between the UPS and PC Network.

DETERMINING THE POWER REQUIREMENTS OF YOUR EQUIPMENT

1. Make sure the total Volt-Amp (VA) requirements of your connected equipment does not exceed the maximum VA rating for the UPS. The maximum VA ratings are shown in the Specifications section of this document.
2. Ensure that the equipment plugged into the battery-powered outlets does not exceed the UPS rated capacity. If UPS rated capacities are exceeded, an overload condition may occur and cause the UPS to shut down and trip the circuit breaker.
3. If the power requirements of your equipment are listed in values other than Volt-Amps (VA), convert Watts (W) or Amps (A) into VA by doing the calculations below. Note: The equation below only calculates the maximum amount of VA that the equipment can use, not what is typically used by the equipment at any given time. Users should expect usage requirements to be approximately 60% of the value to estimate power requirements:

$$\text{_____ Watts (W) x 1.67 = _____ VA or _____ Amps (A) x 120 = _____ VA}$$

Add the totals for all of the equipment and multiply this total by 0.65 to calculate actual power requirements.

Note: Many factors can affect the amount of power that your computer system will require. The total load that you will be placing on the battery-powered outlets should not exceed 85% of the UPS capacity.

HARDWARE INSTALLATION GUIDE

1. Your new UPS may be used immediately upon receipt, however, charging the battery for at least 4 hours is recommended to ensure that the batteries maximum charge capacity is achieved. Charge loss may occur during shipment and storage. To recharge the battery, plug the power cord into the correct type AC wall outlet and turn the power switch on. **Note:** Xtreme Power units will charges the battery with the power switch in either the on or off position.
2. With the UPS off and unplugged, connect your computer, monitor, and/or any other externally powered equipment into the battery power supplied outlets. **DO NOT plug a laser printer, copier, space heater, vacuum, or other large electrical device into the UPS. The power demands of these devices will overload and possibly damage the UPS.**
3. Plug the UPS into a 2 pole, 3 wire grounded receptacle (AC wall outlet) as rated in the Specifications section of this document. Make sure the wall outlet is protected by a fuse or circuit breaker and does not service equipment with large inrush electrical demands (e.g. refrigerator, copier, etc). **Note: DO NOT** use extension cords or power or surge strips on the input or the output of the UPS.

4. Depress the power switch to turn the UPS on. The power on LED indicator, and charging LED will illuminate after the UPS initial test to indicate the UPS is switched "ON".
5. If an overload is detected, an audible alarm will sound and the UPS will emit one long beep every 2-4 seconds. To correct this, turn the UPS off and unplug at least one piece of equipment from the battery-powered outlets. Wait 10 seconds. Make sure the circuit breaker is depressed and then turn the UPS on.
6. Your UPS is equipped with an auto-charge feature. When the UPS is plugged into an AC wall outlet and there is acceptable AC voltage present, the battery will automatically recharge. Charging is controlled by firmware to rapidly charge units to 15VDC (600/800VA units) and 29VDC (1200/1500VA units). After this threshold is met, the XVT places a float charge to maintain battery energy, and the charging light will continue to stay on during this time.
7. To maintain optimal battery charge, leave the UPS plugged into an AC wall outlet with the power switch turned on at all times.
8. To store your UPS for an extended period of time, cover and store it with the battery fully charged. Recharge the battery every two months to maintain battery life.

QUICKSTART SOFTWARE INSTALLATION GUIDE

1. Locate the USB Cable inside the box.
2. Insert one end of the USB Cable into the UPS and the other into a USB port on your computer.
3. Insert the CD into your computers CD drive.
4. When the software interface requests a serial number, locate and input the serial number from the CD software jacket.
5. Follow the software setup prompts.
6. Quickstart Software Installation Guide.

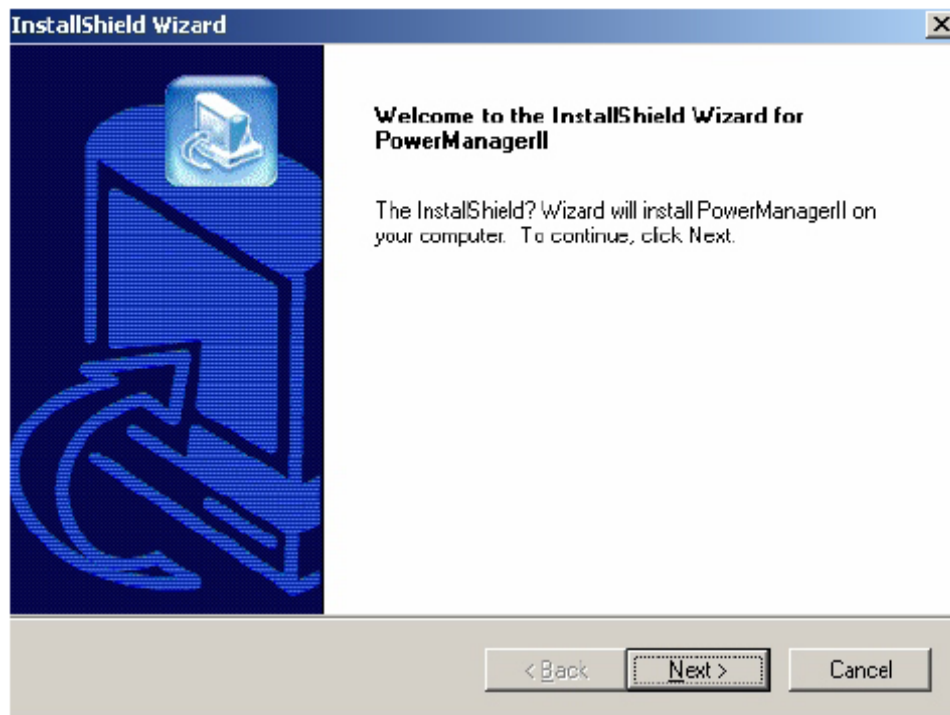

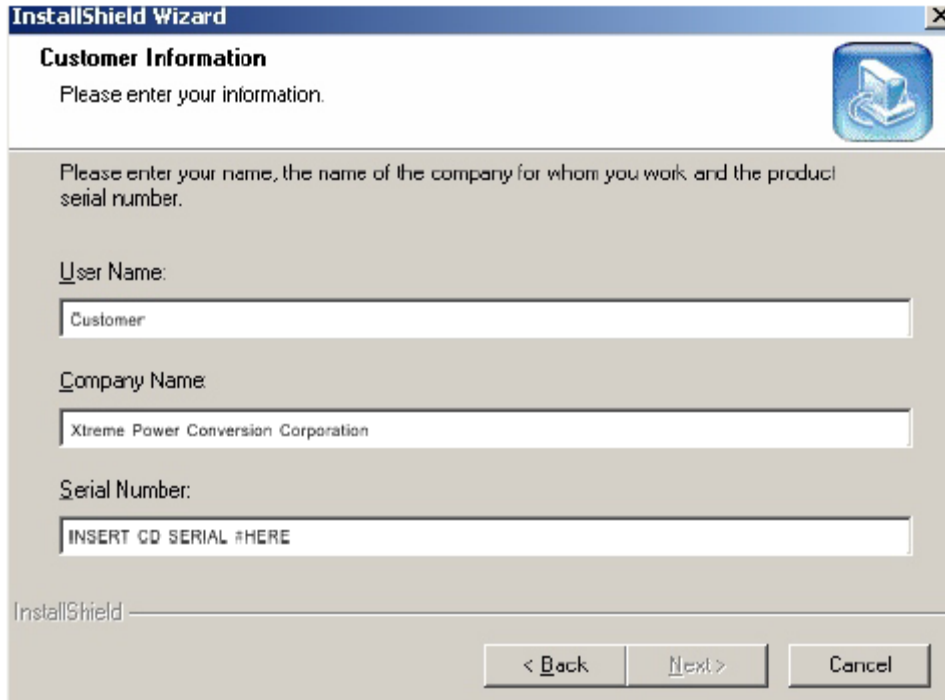

The screenshot shows the 'InstallShield Wizard' window with the 'Customer Information' step. The window title is 'InstallShield Wizard' and it has a close button (X) in the top right corner. The main heading is 'Customer Information' with a sub-heading 'Please enter your information.' and a CD-ROM icon. Below this, there is a text box with the instruction: 'Please enter your name, the name of the company for whom you work, and the product serial number.' There are three input fields: 'User Name' containing 'Customer', 'Company Name' containing 'Xtreme Power Conversion Corporation', and 'Serial Number' containing 'INSERT CD SERIAL #HERE'. At the bottom, there are three buttons: '< Back', 'Next >', and 'Cancel'. The 'InstallShield' logo is visible in the bottom left corner.

Input user name, company name and serial number into the software interface.

Note: the serial number is on the CD software jacket.

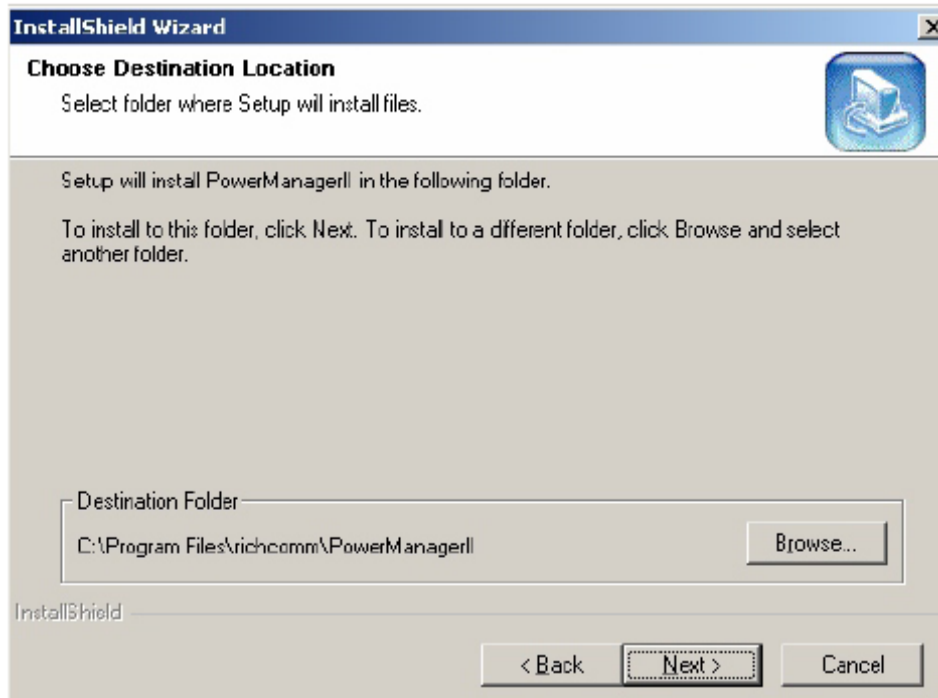

The screenshot shows the 'InstallShield Wizard' window with the 'Choose Destination Location' step. The window title is 'InstallShield Wizard' and it has a close button (X) in the top right corner. The main heading is 'Choose Destination Location' with a sub-heading 'Select folder where Setup will install files.' and a CD-ROM icon. Below this, there is a text box with the instruction: 'Setup will install PowerManagerII in the following folder.' followed by 'To install to this folder, click Next. To install to a different folder, click Browse and select another folder.' There is a 'Destination Folder' input field containing 'C:\Program Files\richcomm\PowerManagerII' and a 'Browse...' button to its right. At the bottom, there are three buttons: '< Back', 'Next >', and 'Cancel'. The 'InstallShield' logo is visible in the bottom left corner.

Choose installation location and click "Next"

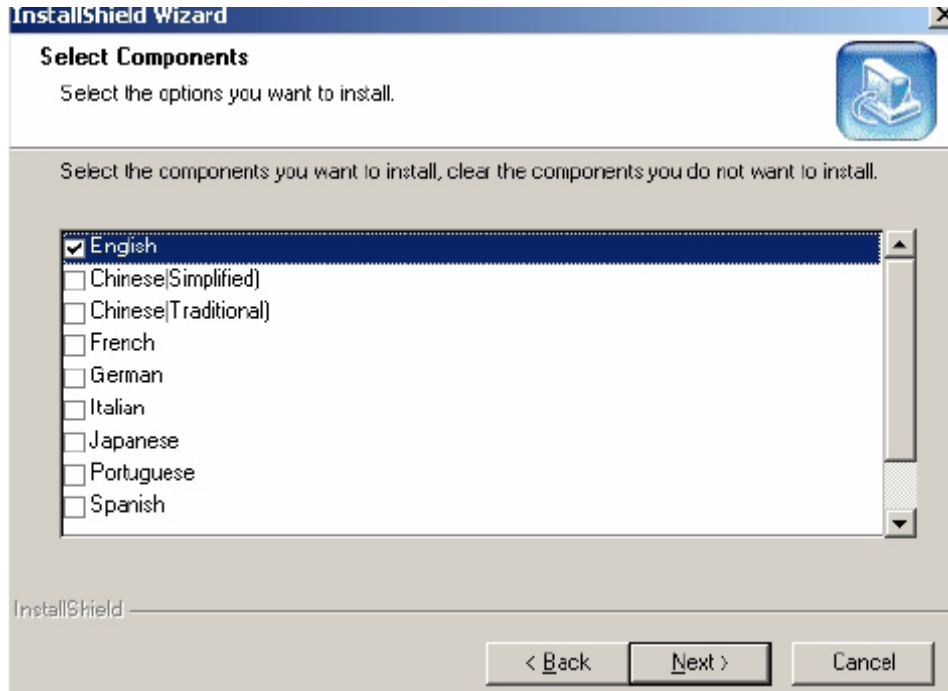

Choose software language and click "Next"

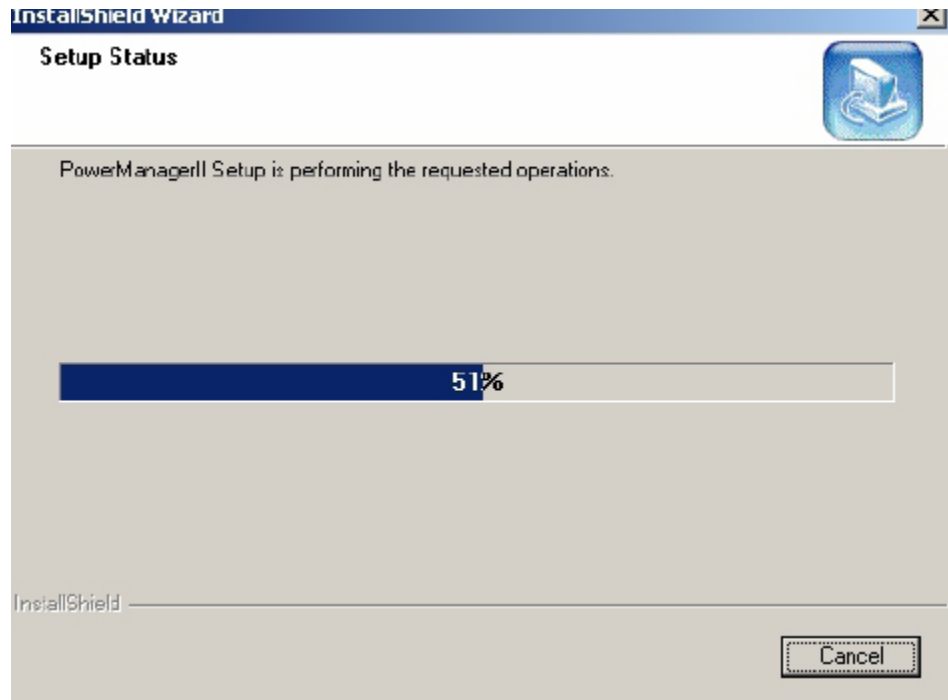

Software will install automatically

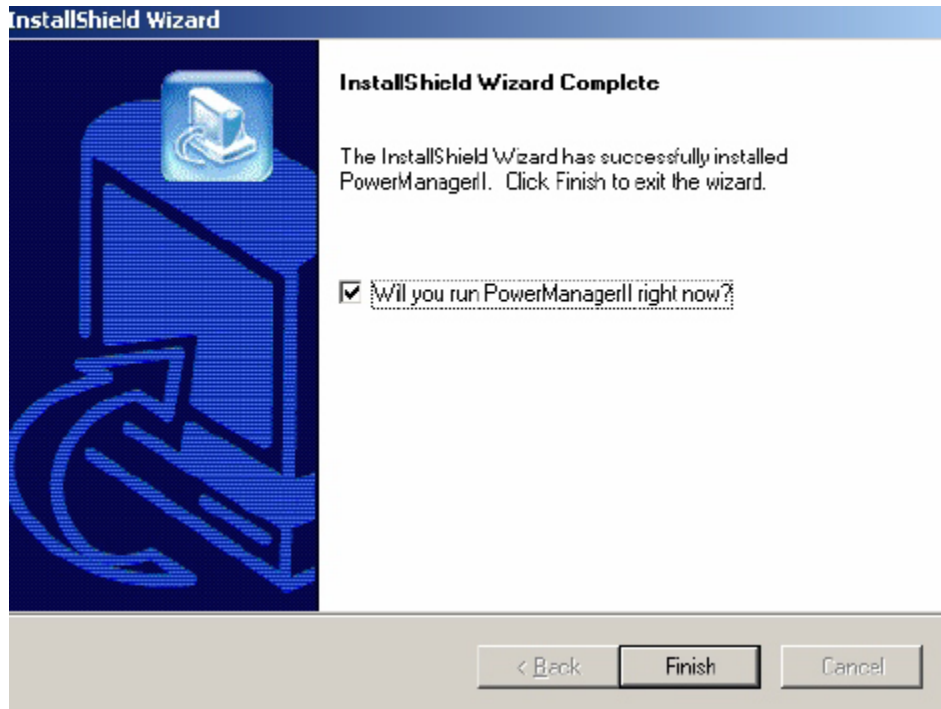

Choose "Will you run Powermanager II right now?" and click "Finish"

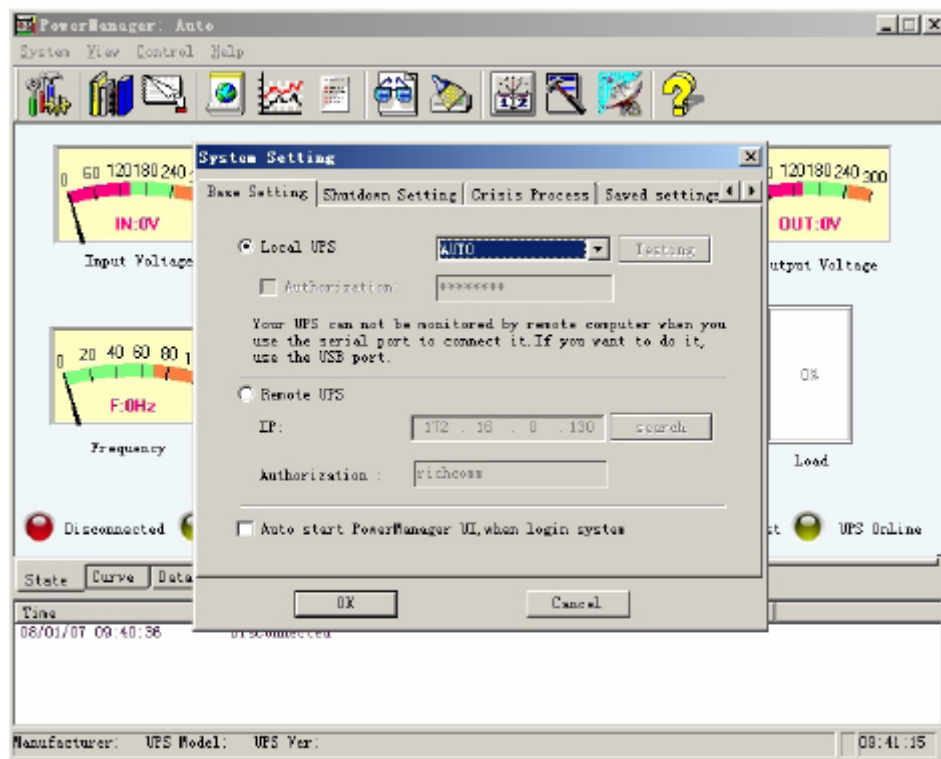

After the UPS switches on, please choose the "System Setting" tab from the drop down box

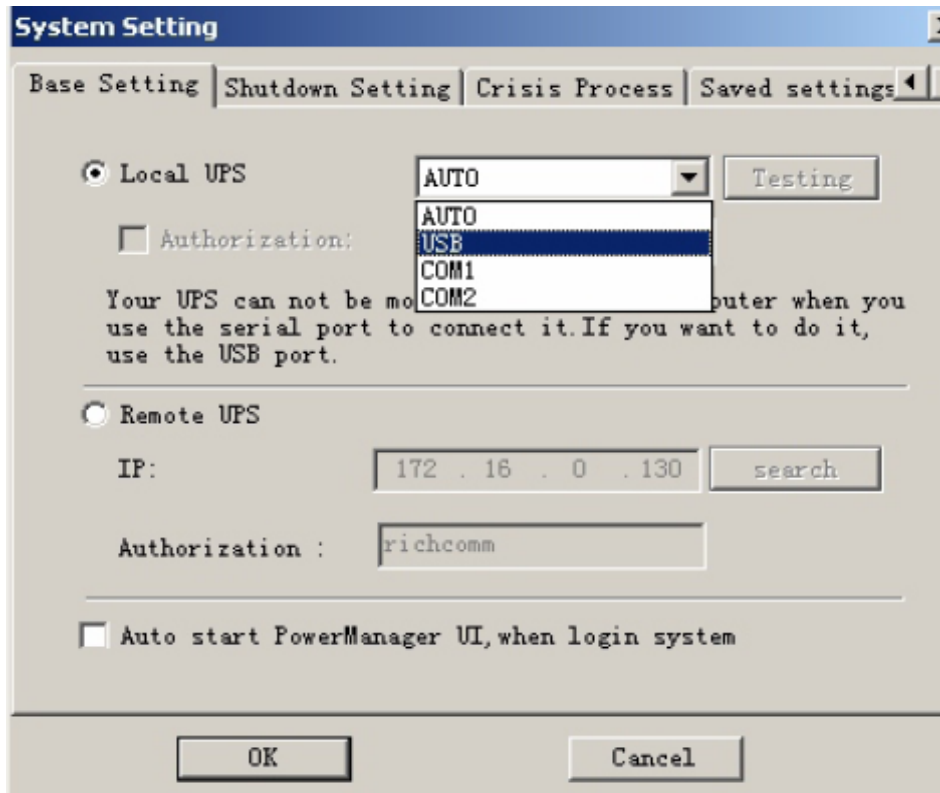

Click "Local UPS" and choose "USB" click "OK"

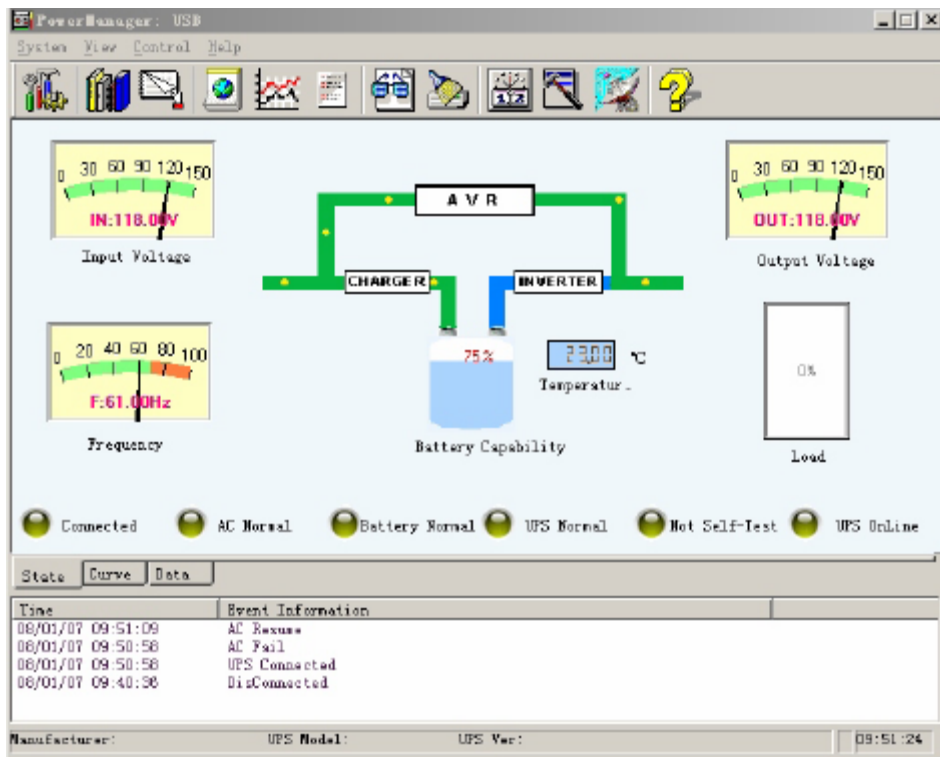

The UPS is now connected and in normal operation.

REPLACING THE BATTERY

(QUALIFIED SERVICE PERSONNEL ONLY)

CAUTION! Read and follow the IMPORTANT SAFETY INSTRUCTIONS before servicing the battery. Service the battery under the supervision of Qualified Service Personnel knowledgeable of batteries and their precautions.

CAUTION! Use only the specified type of battery. See your dealer for replacement batteries.

CAUTION! The battery may present risk of electrical shock. Do not dispose of batteries in a fire as it may explode. Follow all local ordinances regarding proper disposal of batteries.

CAUTION! Do not open or mutilate the batteries. Released electrolyte is harmful to skin and eyes and may be toxic.

CAUTION! Although the battery system voltage is only 12VDC and 24VDC, the battery can present a high risk of short circuit current and electrical shock. The short circuit current capability of the battery is sufficient to burn wire or tools very rapidly, producing molten metal. Observe these precautions when replacing the battery:

1. Remove all watches, rings or other metal objects.
2. Only use tools with insulated handles.
3. Do not lay tools or metal parts on top of battery or any terminals.
4. Wear protective eye wear (goggles), rubber gloves and boots.
5. Disconnect the charging source before connecting or disconnecting the battery terminals.
6. Determine if the battery is inadvertently grounded. If inadvertently grounded, remove the source of the ground. Contact with a grounded battery can result in electrical shock! The likelihood of such shock will be reduced if such grounds are removed during installation and maintenance (applicable to a UPS and a remote battery supply not having a grounded circuit).

DEFINITIONS FOR LED INDICATORS

LED 1 (green)	LED 2 (yellow)	LED 3 (red)	Unit Status
ON	*	OFF	On AC Power
OFF	OFF	FLASH	On Battery
*	ON	*	Charge
*	*	ON	Overheat
			Low Battery
			Overload Protection
			Short Circuit

Note: * means any situation



ALARMS

Alarm Indication	Unit Status
Buzzer every 5 sec	DC start
Buzzer every 1 sec	Self test
2 buzzer every 1 sec	Low battery
4 beep every 2.4 sec	Overload
3 buzzer every 1 sec	Overheat
Input is off, long beep, power off after 5 sec	Short circuit

TROUBLESHOOTING

PROBLEM	POSSIBLE CAUSE	SOLUTION
Full-time surge protection outlets stop providing power to equipment	Circuit breaker has tripped due to an overload	Turn the UPS off & unplug at least one piece of equipment. Wait 10 sec, replace the fuse with a fuse of like size & rating, & turn the UPS on
The UPS does not supply expected runtime	Battery not fully charged	Recharge the battery for at least 4 hours
	The battery is defective	Contact Xtreme Power Conversion about replacement of batteries
The UPS will not turn on	The on/off switch is designed to prevent damage by rapidly turning it off and on	Turn the UPS off. Wait 10 sec & then turn the UPS on
	The UPS is not plugged into an AC wall outlet	Connect the UPS to an 110/120V 60Hz AC wall outlet
	The battery is defective	Contact Xtreme Power Conversion about replacement of batteries
	Mechanical problem	Contact Xtreme Power Conversion
The UPS shuts down when there is loss of AC power	The UPS is not providing battery power	Shutdown your load & turn the UPS off. Wait 10 sec & turn the UPS back on. This should reset the UPS

SPECIFICATIONS

	120V Model	XVT-600	XVT-800	XVT-1200	XVT-1500
INPUT	Voltage	94V-144V \pm 5V			
	Capacity VA (W)	600 VA (360 W)	800 VA (480 W)	1200 VA (720 W)	1440 VA (900 W)
	Frequency	60HZ \pm 5Hz			
OUTPUT	Voltage	105-134 VAC (120V \pm 12%)			
	Waveform	Pure Sine Wave (Typical)			
	Frequency	AC mode-follow utility Battery mode 60 \pm 0.5Hz			
	Transfer Time	4ms (Typical)			
	Surge Protection	320 Joules			
	Input Protection	Compliance with IEEE 587			
	Short Circuit	Breaker			
BATTERY	Battery Type	Sealed, Maintenance-free lead acid			
	Battery Qty & Size	(1) 12V 7AH	(1) 12V 9AH	(2) 12V 7AH	(2) 12V 9AH
	Recharge	less than 10 hours to 90% capacity			
	Backup Time (full load) & (half load)	3 min (full load) \geq 6 min (50% load)			
	Charge Current	1.5A (Max)			
PHYSICAL	Dimensions	W x D x H (inches)	W x D x H (inches)	W x D x H (inches)	W x D x H (inches)
	Product Dimensions	3.7" x 14.6" x 6.2"	3.7" x 14.6" x 6.2"	4.9" x 16.9" x 8.7"	4.9" x 16.9" x 8.7"
	Shipping Dimensions	6.1" x 16.2" x 10.2"	6.1" x 16.2" x 10.2"	7.5" x 18.9" x 12.8"	7.5" x 18.9" x 12.8"
	Product Weight	15.3 lbs.	16.8 lbs.	27.6 lbs.	31.3 lbs.
	Shipping Weight	17.6 lbs.	19.2 lbs.	29.8 lbs.	32.4 lbs.
	Line Cord (6 ft.)	NEMA 5-15P			
	Receptacles	(6) NEMA 5-15R (3-SURGE PROTECTED/3-UPS)			
	Communication Interface	USB Communications			
	Bezel Color	Brushed Metallic Outer / Black Inner			
	Included in box	PowerManager CD, USB cable, Manual			
ENVIRONMENT	Operating Temperature	0-35°C			
	Humidity	0%-90%			
	Audible Noise	<45dB			
	Altitude	11,500 ft (3500 m) above sea level			
WARRANTY	Warranty	Two years electronics / Two year batteries			
APPROVALS	North America	UL cUL FCC			

	120V Model	XVT-600	XVT-800	XVT-1200	XVT-1500
INDICATORS & ALARMS	AC Mode	Green LED on, Orange LED on, Red LED off, no beep			
	Charging Battery	Orange LED on until 80% charge			
	Battery Mode	Green LED and Orange LED off, Red LED flash, buzzer slow beep			
	Battery Low	Green LED and Orange LED off, Red LED on, buzzer fast beep			

SHIPPING LIST

1. (1) UPS
2. (1) User's and Installation Manual
3. (1) Intelligent monitoring software
4. (1) USB computer port cable

OBTAINING SERVICE

If the UPS requires Service:

1. Use the TROUBLESHOOTING section in this manual to eliminate obvious causes.
2. Verify there are no circuit breakers tripped.
3. Call your dealer for assistance. If you cannot reach your dealer, or if they cannot resolve the problem, call Xtreme Power Conversion Corp Technical Support at 800.582.4524. Technical support inquiries can also be made at support@xpcc.com. Please have the following information available BEFORE calling the Technical Support Department:
 - a. Your name and address.
 - b. The serial number of the unit.
 - c. Where and when the unit was purchased.
 - d. All of the model information about your UPS.
 - e. Any information on the failure, including LED's that may or may not be illuminated.
 - f. A description of the protected equipment, including model numbers if possible.

A technician will ask you for the above information and, if possible, help solve your problem over the phone. In the event that the unit requires factory service, the technician will issue you a Return Material Authorization number (RMA).

If you are returning the UPS to Xtreme Power for service, please follow these procedures:

1. Pack the UPS in its original packaging. If the original packaging is no longer available, ask the Technical Support Technician about obtaining a replacement set of packaging material. It is important to pack the UPS properly in order to avoid damage in transit. Never use Styrofoam beads for a packing material.
2. Include a letter with your name, address, daytime phone number, RMA number, a copy of your original sales receipt, and a brief description of the problem.
3. Mark the RMA number on the outside of all packages. Xtreme Power cannot accept any package without the RMA number marked on the outside of the boxes.
4. Return the UPS by insured, prepaid carrier to the address provided by the Technician.

Refer to the Warranty statements in this manual for additional details on what is covered.

XTREME POWER CONVERSION® (XPC) CORPORATION LIMITED WARRANTY

Xtreme Power Conversion (XPC) Corporation warrants Xtreme Power Conversion equipment, when properly applied and operated within specified conditions, against faulty materials or workmanship (excluding batteries) for a period of *two years for XVT-Series products* from the date of purchase. XPC Corporation warrants *internal batteries for a period of two years* from the date of purchase. For equipment sites within the United States and Canada, this warranty covers repair or replacement, at the sole discretion of XPC Corporation. The customer is responsible for the costs of shipping the defective product to XPC Corporation. XPC Corporation will pay for ground shipment of the repaired or replacement product. This warranty applies only to the original purchaser.

If equipment provided by XPC Corporation is found to be **Dead-on-Arrival (DOA)**, XPC Corporation will be responsible for the costs of shipping product to and returning equipment from the customer in a timely manner as agreed to with the customer, once the customer has requested and received a **Return Material Authorization (RMA)** number. DOA equipment is defined as equipment that does not properly function according to user documentation when initially received and connected in conjunction with proper procedures as shown in the user documentation or via support provided by XPC Corporation personnel or authorized agents.

This warranty shall be void if (a) the equipment is repaired or modified by anyone other than XPC Corporation or a XPC Corporation approved third party; (b) the equipment is damaged by the customer, is improperly used or stored, is subjected to an adverse operating environment, or is operated outside the limits of its electrical specifications; or (c) the equipment has been used or stored in a manner contrary to the equipment's operating manual, intended use or other written instructions. Any technical advice furnished by XPC Corporation or a XPC Corporation authorized representative before or after delivery with regard to the use or application of Xtreme Power Conversion equipment is furnished on the basis that it represents XPC Corporations best judgment under the situation and circumstances, but it is used at the recipient's sole risk.

EXCEPT AS STATED ABOVE, XPC Corporation DISCLAIMS ALL WARRANTIES, EXPRESSED OR IMPLIED, INCLUDING WARRANTIES OF MERCHANTABILITY AND FITNESS FOR A PARTICULAR PURPOSE.

EXCEPT AS STATED ABOVE, IN NO EVENT WILL XPC Corporation BE LIABLE FOR DIRECT, INDIRECT, SPECIAL, INCIDENTAL, OR CONSEQUENTIAL DAMAGES ARISING OUT OF THE USE OF Xtreme Power Conversion EQUIPMENT, including but not limited to, any costs, lost profits or revenue, loss of equipment, loss of use of equipment, loss of software, loss of data, cost of substitutes, or claims by third parties..Purchaser's sole and exclusive remedy for breach of any warranty, expressed or implied, concerning Xtreme Power Conversion equipment, and the only obligation of XPC Corporation under this warranty, shall be the repair or replacement of defective equipment, components, or parts; or, at XPC Corporations sole discretion, refund of the purchase price or substitution of an equivalent replacement product.

XTREME POWER CONVERSION® LOAD PROTECTION POLICY

For Standard EPC 120, 208 and 240 Volt Products used in the United States and Canada

THIS POLICY IS NOT A WARRANTY. REFER TO **THE XPC CORPORATION, INC. LIMITED WARRANTY** FOR INFORMATION CONCERNING THE WARRANTY FOR YOUR XPC PRODUCT. THE LIMITATIONS AND CONDITIONS CONTAINED IN THIS POLICY DO NOT AFFECT **THE TERMS OF THE XPC LIMITED WARRANTY**.

Definitions:

1. "Product" means an XPC Standard EPC 120, 208, or 240 Volt power protection device that is used in the United States and Canada. This policy does not include custom manufactured products.
2. "Power Disturbance" means an AC power line transient (telephone line, local Area Network or CATV transients, if applicable), spike or surge.
3. "Fair Market Value" of damaged Connected Equipment as determined by XPC shall be the lower of (a) the average price the same or similar items are being sold for on eBay, (b) the price list of Orion Blue Book (or if such price list is no longer published, a published or announced price list reasonably selected by XPC), (c) the lowest price the same or similar items can be purchased for in the United States or (d) the total amount of all payment(s) you have or are entitled to receive from insurance, other warranties, extended warranties, a legal liability claim or from other sources or persons for the damaged Connected Equipment.
4. "Initial Purchaser," "Purchaser" or "You" means the person or entity that originally purchased the Product from an authorized reseller or distributor of XPC Products.

The Initial Purchaser of this Product is protected, for the term of the XPC Limited Warranty, against certain losses caused by a Power Disturbance for properly connected electronic equipment (referred to as the "Connected Equipment") subject to certain terms and conditions provided below.

This policy applies only to the original purchaser of the Product. If the Product is transferred or sold to another person or entity, this policy is void.

Load Protection Policy Dollar and Period Limits

For purchasers that meet the qualifications and conditions set forth in this policy, XPC will provide reimbursement (cost of repair or fair market value as determined by XPC) during the period limits and up to the dollar limits stated as follows:

Product	Dollar limit	Period of Coverage
XVT	25,000	Term of XPC Limited Warranty
NXRT-XPRT- 6 kva	50,000	Term of XPC Limited Warranty
NXRT-XPRT-10 kva	50,000	Term of XPC Limited Warranty

This Load Protection Policy is not deemed "first dollar" coverage. XPC's obligation is reduced by any amounts that the Initial Purchaser is entitled to recover, from other sources regarding the Connected Equipment, including, but not limited to, insurance, other warranty, extended warranty, or legal liability, regardless of whether or not the Initial Purchaser makes a claim for recovery.

Eligibility for coverage under the Load Protection Policy

1. The Product must be registered on the XPC website, www.xtremepowerconversion.com, within 10 days of purchase. All required information must be provided, and Purchaser should retain a copy for Purchaser's records. When registering on the website, Purchaser must list all connected equipment that is directly connected to the product. Only those devices registered in that manner will be covered.
2. All Connected Equipment must be UL or CSA approved.
3. The Product must be plugged into a properly wired and grounded outlet. Use of input surge devices, extension cords, adapters, ground wires, or electrical connections not manufactured by XPC voids the XPC Load Protection Policy. No other surge protection device may be connected to the output sockets of the Product. The installation must comply with all applicable electrical and safety codes set forth pursuant to the NEC.
4. The Product must have undeniable physical evidence of a Power Disturbance that directly and proximately caused the damage;
5. The Connected Equipment must have been damaged by a Power Disturbance on a properly installed, grounded, and National Electric Code, ("NEC"), code-compliant 120, 208, 240-volt AC power line in the United States or Canada, by a Power Disturbance on standard telephone land line or PBX telephone equipment line that is properly installed and connected to an RJ11 port on the Product; or by a Power Disturbance on a standard Local Area Network connection that is properly installed and connected to an RJ45 port on the Product and (d) is directly plugged into, and properly connected to, the Product in its original condition which was properly operated when a Power Disturbance passed through the Product and (i) exhausts the protection capacity of the Product or (ii) damages the Product.
6. The Load Protection Policy does not apply if the Product has been operated in a failure mode or not in compliance with XPC operating instructions in the Product user's manual, or if the Connected Equipment has not been operated in compliance with the instructions and manuals of its manufacturer/vendor.
7. This policy is null and void if, XPC determines, in its sole discretion, that the Product has been tampered with or altered in any way.

What is Not Covered Under the Load Protection Policy:

The following damage is not covered by this Policy:

1. Restoration of lost data and reinstallation of software.
2. Damage from a cause other than AC power-line transients, except for damage due to telephone line, Local Area Network, or CATV transients, which is covered only if the Product offers such protection.
3. DAMAGE CAUSED BY FAILURE TO PROVIDE A SUITABLE INSTALLATION ENVIRONMENT FOR THE PRODUCT (INCLUDING, BUT NOT LIMITED TO, LACK OF A PROPER SAFETY GROUND).
4. Damage caused by the use of the Product for purposes other than those for which it was designed.
5. Damage caused by accidents, or natural disasters, including but not limited to, fire, flood, and wind.
6. Damage caused by abuse, misuse, alteration, modification, or negligence.
7. Any labor costs or travel, room and board expenses associated with the repair and/or restoration of lost or damaged hardware, software or data.

EXCEPT AS EXPRESSLY PROVIDED IN THIS POLICY, XPC SHALL NOT BE LIABLE FOR ANY DAMAGES WHATSOEVER, INCLUDING, BUT NOT LIMITED TO, DIRECT, INDIRECT, SPECIAL, INCIDENTAL, CONSEQUENTIAL, OR MULTIPLE DAMAGES ARISING OUT OF THE USE OF THE PRODUCT OR DAMAGE TO THE CONNECTED EQUIPMENT, REGARDLESS OF THE LEGAL THEORY ON WHICH SUCH CLAIM IS BASED, EVEN IF ADVISED OF THE POSSIBILITY OF SUCH DAMAGE. SUCH DAMAGES INCLUDE, BUT ARE NOT LIMITED TO, LOSS OF PROFITS, LOSS OF SAVINGS OR REVENUE, LOSS OF USE OF THE PRODUCT OR THE CONNECTED EQUIPMENT OR ANY ASSOCIATED EQUIPMENT, LOSS OF SOFTWARE, COST OF CAPITAL, COST OF ANY SUBSTITUTE EQUIPMENT, FACILITIES OR SERVICES, DOWNTIME, THE CLAIMS OF THIRD PARTIES, INCLUDING CUSTOMERS, AND INJURY TO PROPERTY.

Submitting a Load Protection Policy Claim:

1. Any claim under the Load Protection Policy must be made **within 10 days** of the date of alleged damage to the Connected Equipment.
2. Call the XPC technical support department at 1-800- 582-4524 and obtain a Load Protection Policy Returned Material Authorization (RMA) number. Have information on all applicable insurance or other resources of recovery/payment that are available to the Initial Purchaser and the name of the power utility supplier for the location of the Connected Equipment. XPC will forward to you a Load Protection Policy claims form, which must be completed and filed with XPC within 30 days.
 - a. Mark the Load Protection Policy RMA number on the Product you are returning.
 - b. Pack the Product in its original packaging or similar packing materials if the original packaging has been discarded. Enclose the completed Load Protection Policy claim form and a copy of your original sales receipt for the Product in the box.
 - c. Mark the RMA number clearly on the outside of the box.
 - d. Ship the Product (one-way shipping charges paid by you) to:

XPC Corporation
230 Yuma Street
Denver, Colorado 80439
Attn: LPP RMA#
3. XPC will evaluate the Product to determine its level of functionality, and will examine the Product for evidence of damage from a Power Disturbance..
 - a. If XPCs' evaluation provides no evidence of damage from a Power Disturbance, XPC will send to the Purchaser (i) a report summarizing the tests performed and (ii) a rejection of claim notice.
 - b. If the Product shows evidence of damage from a Power Disturbance, XPC will request that all Connected Equipment for which a Load Protection Policy claim has been submitted, be sent for evaluation to either XPC or an authorized service center. If it is determined that the Connected Equipment has been damaged by a Power Disturbance, XPC will, in its sole discretion, issue payment to you for either the cost of repair of the Connected Equipment or the Fair Market Value of the damaged Connected Equipment, up to the dollar limits stated above. XPC reserves the right to require you to transfer title and deliver the Connected Equipment to XPC if it chooses to reimburse you for the fair market value of the Connected Equipment. XPCs' maximum liability shall be reduced to reflect all such other payments or sources of recovery, whether applied for or not.
4. If XPC issues payment to you to have the Connected Equipment repaired, the repair must be performed at a service center that is authorized by the manufacturer of the Connected Equipment. XPC reserves the right to contact the authorized service center directly to discuss repair costs and damage to the Connected Equipment to determine if it was caused by a Power Disturbance and the right to request that the service center forward the Connected Equipment or components of the Connected Equipment to XPC for inspection
5. Unless modified in writing signed by an officer of XPC and you, the terms of this policy are the complete and exclusive agreement between the parties, superseding all prior agreements, oral or written, and all other communications between the parties relating to the subject matter of this agreement. No employee of XPC or any other party is authorized to make any representations beyond those made in this agreement concerning the Load Protection Policy.

XPC Corporation
230 Yuma Street
Denver, Colorado 80223
1.800.582.4524