

Powerware Series

**Eaton® 5125 Rack-Mount UPS**  
**5000/6000 VA**  
**User's Guide**



*Powering Business Worldwide*

**This product is covered by one or more of the following US Patent numbers: 5177676, 6314007, 6330176, 6391489, 6483730, and 6599657.**

## **Requesting a Declaration of Conformity**

Units that are labeled with a CE mark comply with the following harmonized standards and EU directives:

- Harmonized Standards: IEC 62040-1-1 and IEC 62040-2; IEC 60950 Third Edition
- EU Directives: 73/23/EEC, Council Directive on equipment designed for use within certain voltage limits  
93/68/EEC, Amending Directive 73/23/EEC  
89/336/EEC, Council Directive relating to electromagnetic compatibility  
92/31/EEC, Amending Directive 89/336/EEC relating to EMC

The EC Declaration of Conformity is available upon request for products with a CE mark. For copies of the EC Declaration of Conformity, contact:

Eaton Power Quality Oy  
Koskelontie 13  
FIN-02920 Espoo  
Finland  
Phone: +358-9-452 661  
Fax: +358-9-452 665 68

Eaton, Powerware, ABM, FERRUPS, LanSafe, and X-Slot are registered trademarks and ConnectUPS is a trademark of Eaton Corporation or its subsidiaries and affiliates. Modbus is a registered trademark of Schneider Automation. Microsoft is a registered trademark of Microsoft Corporation in the United States and other countries. National Electrical Code and NEC are registered trademarks of National Fire Protection Association, Inc. All other trademarks are property of their respective companies..

©Copyright 2004–2010 Eaton Corporation, Raleigh, NC, USA. All rights reserved. No part of this document may be reproduced in any way without the express written approval of Eaton Corporation.

## Class A EMC Statements

### FCC Part 15

NOTE This equipment has been tested and found to comply with the limits for a Class A digital device, pursuant to part 15 of the FCC Rules. These limits are designed to provide reasonable protection against harmful interference when the equipment is operated in a commercial environment. This equipment generates, uses, and can radiate radio frequency energy and, if not installed and used in accordance with the instruction manual, may cause harmful interference to radio communications. Operation of this equipment in a residential area is likely to cause harmful interference in which case the user will be required to correct the interference at his own expense.

### ICES-003

This Class A Interference Causing Equipment meets all requirements of the Canadian Interference Causing Equipment Regulations ICES-003.

Cet appareil numérique de la classe A respecte toutes les exigences du Règlement sur le matériel brouilleur du Canada.

### IEC 62040-2

Some configurations are classified under IEC 62040-2 as "Class-A UPS for Unrestricted Sales Distribution." For these configurations, the following applies:

**WARNING** This is a Class A-UPS Product. In a domestic environment, this product may cause radio interference, in which case, the user may be required to take additional measures.

### VCCI Notice

この装置は、情報処理装置等電波障害自主規制協議会（VCCI）の基準に基づくクラスA情報技術装置です。この装置を家庭環境で使用すると電波妨害を引き起こすことがあります。この場合には使用者が適切な対策を講ずるよう要求されることがあります。

## Special Symbols

The following are examples of symbols used on the UPS or accessories to alert you to important information:



**RISK OF ELECTRIC SHOCK** - Observe the warning associated with the risk of electric shock symbol.



**CAUTION: REFER TO OPERATOR'S MANUAL** - Refer to your operator's manual for additional information, such as important operating and maintenance instructions.



This symbol indicates that you should not discard the UPS or the UPS batteries in the trash. This product contains sealed, lead-acid batteries and must be disposed of properly. For more information, contact your local recycling/reuse or hazardous waste center.



This symbol indicates that you should not discard waste electrical or electronic equipment (WEEE) in the trash. For proper disposal, contact your local recycling/reuse or hazardous waste center.

# Table of Contents

<b>1</b>	<b>Introduction</b>	<b>1</b>
<b>2</b>	<b>Safety Warnings</b>	<b>3</b>
<b>3</b>	<b>Installation</b>	<b>19</b>
	Inspecting the Equipment	19
	Installation Overview	20
	Installing the Rail Kit	21
	Installing the UPS Internal Batteries	27
	Extended Battery Module Installation	29
	Remote Emergency Power-off Installation	30
	Plug-Receptacle UPS Installation	32
	Hardwired UPS Installation	34
<b>4</b>	<b>Operation</b>	<b>39</b>
	Turning the UPS On	39
	Starting the UPS on Battery	39
	Turning the UPS Off	40
	Initiating the Self-Test	40
	Operating Modes	41
	Normal Mode	41
	Battery Mode	42
	Bypass Mode	42
	Standby Mode	42
<b>5</b>	<b>Configuration</b>	<b>43</b>
<b>6</b>	<b>Additional UPS Features</b>	<b>47</b>
	USB Port	47
	DB-9 Communication Port	48
	X-Slot Cards	49
	The ConnectUPS-X Web/SNMP Card	50
	Load Segments	51
<b>7</b>	<b>UPS Maintenance</b>	<b>53</b>
	UPS and Battery Care	53
	Storing the UPS and Batteries	53

## TABLE OF CONTENTS

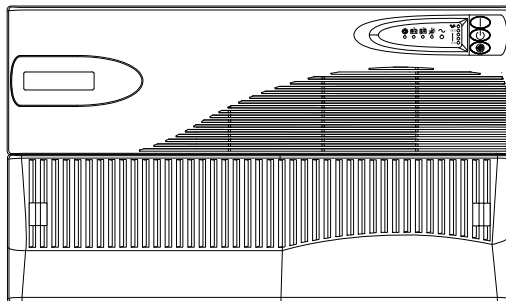
Replacing the Electronics Module .....	54
When to Replace Batteries .....	55
Replacing Batteries .....	55
How to Replace UPS Internal Batteries .....	56
How to Replace Extended Battery Modules .....	57
Recycling the Used Battery or UPS .....	59
<b>8 Specifications .....</b>	<b>61</b>
<b>9 Troubleshooting .....</b>	<b>65</b>
Audible Alarms and UPS Conditions .....	65
Silencing an Audible Alarm .....	65
Service and Support .....	69
<b>10 Warranty .....</b>	<b>71</b>
Two-Year Limited Warranty with Extension to Three-Year Limited Warranty (US and Canada) .....	71
Load Protection Guarantee (US and Canada) .....	73

# Chapter 1 Introduction

The Eaton® 5125 uninterruptible power system (UPS) protects your sensitive electronic equipment from basic power problems such as power failures, power sags, power surges, brownouts, and line noise.

Power outages can occur when you least expect it and power quality can be erratic. These power problems have the potential to corrupt critical data, destroy unsaved work sessions, and damage hardware — causing hours of lost productivity and expensive repairs.

With the Eaton 5125, you can safely eliminate the effects of power disturbances and guard the integrity of your equipment. The Eaton 5125 is designed for critical applications such as workstations, servers, networks, telecommunications equipment, and rack applications. Figure 1 shows the Eaton 5125 UPS with an optional Extended Battery Module (EBM).



**Figure 1. The Eaton 5125 UPS with Optional EBM**

Providing outstanding performance and reliability, the Eaton 5125's unique benefits include the following:

- ABM® technology that uses advanced battery management to increase battery service life, optimize recharge time, and provide a warning before the end of useful battery life.
- Hours of extended runtime with up to four EBMs.
- Start-on-battery capability for powering up the UPS even if utility power is not available.

- Hot-swappable electronics module and batteries that simplify maintenance by allowing you to replace them safely without powering down the critical load.
- Emergency shutdown control through the remote emergency power-off (REPO) port.
- Two standard communication options with a USB port and a DB-9 serial port.
- Optional X-Slot® cards with enhanced communication capabilities for increased power protection and control.
- Advanced power management with the Software Suite CD for graceful shutdowns and power monitoring.
- Sequential shutdown and load management through separate receptacle groups, called load segments.
- Backed by worldwide agency approvals.



## Chapter 2 Safety Warnings

### IMPORTANT SAFETY INSTRUCTIONS SAVE THESE INSTRUCTIONS

---

This manual contains important instructions that you should follow during installation and maintenance of the UPS and batteries. Please read all instructions before operating the equipment and save this manual for future reference.

---

#### DANGER



This UPS contains **LETHAL VOLTAGES**. All repairs and service should be performed by **AUTHORIZED SERVICE PERSONNEL ONLY**. There are **NO USER SERVICEABLE PARTS** inside the UPS.

---

#### WARNING



- This UPS contains its own energy source (batteries). The output receptacles may carry live voltage even when the UPS is not connected to an AC supply.
  - For 200–240V models, the output receptacles may remain electrically live. If the input power source in your application is wired line-to-neutral (as in most European applications), the voltage to the output receptacles is 0V. With line-to-line input wiring, the voltage to the output receptacles is 100–120V (measured from line-to-ground or line-to-neutral, depending on the UPS wiring).
  - Do not remove or unplug the input cord when the UPS is turned on. This removes the safety ground from the UPS and the equipment connected to the UPS.
  - To reduce the risk of fire or electric shock, install this UPS in a temperature and humidity controlled, indoor environment, free of conductive contaminants. Ambient temperature must not exceed 40°C (104°F). Do not operate near water or excessive humidity (95% maximum).
  - For UPS models with hardwired outputs, overcurrent protection for the output AC circuit(s) is to be provided by others.
  - For UPS models with hardwired outputs, suitably rated disconnect switches for the output AC circuit(s) are to be provided by others.
-



## CAUTION

- Batteries can present a risk of electrical shock or burn from high short-circuit current. Observe proper precautions. Servicing should be performed by qualified service personnel knowledgeable of batteries and required precautions. Keep unauthorized personnel away from batteries.
- Proper disposal of batteries is required. Refer to your local codes for disposal requirements.
- Never dispose of batteries in a fire. Batteries may explode when exposed to flame.

## Sikkerhedsanvisninger

### VIGTIGE SIKKERHEDSANVISNINGER GEM DISSE ANVISNINGER

Denne manual indeholder vigtige instruktioner, som skal følges under installation og vedligeholdelse af UPS'en og batterierne. Læs venligst alle instruktioner inden betjening af udstyret og gem denne manual mhp. fremtidige opslag.



## FARE

Denne UPS indeholder LIVSFARLIG HØJSPÆNDING. Alle reparationer og vedligeholdelse bør kun udføres af en AUTORISERET SERVICE TEKNIKER. Ingen af UPS'ens indvendige dele kan repareres af brugeren.



## ADVARSEL!

- Denne UPS indeholder sin egen energikilde (batterier). Udgangsstikkene kan endog være strømførende, når UPS'en ikke er koblet til en vekselstrømsforsyning.
- På 200–240V-modeller kan udgangsstikkene være strømførende. Hvis ledningsføringen til indgangsstrømkilden på din enhed er fase-til-neutral (som på de fleste europæiske enheder), er spændingen til udgangsstikkene 0V. Med en fase-til-fase indgangsledningsføring er spændingen til udgangsstikkene 100–120V (målt fra fase-til-jord eller fase-til-neutral, afhængig af UPS-ledningsføringen).
- Netledningen må ikke fjernes og stikket må ikke trækkes ud, mens UPS'en er tændt. Dette fjerner sikkerhedsjorden fra UPS'en og fra det udstyr, der er sat til.
- Installér denne UPS i et temperatur- og fugtighedskontrolleret indendørs miljø, frit for ledende forureningsstoffer for at formindske risikoen for brand og elektrisk stød. Rumtemperaturen må ikke overstige 40°C. UPS'en bør ikke betjenes nær vand eller høj fugtighed (maksimalt 95%).

- For UPS systemer med hårdledningsudgange, skal overstrømsbeskyttelse for vekslestrømmens udgangskredsløb forsynes af andre.
- For UPS systemer med hårdledningsudgange, skal egnede, nominelle afbryderkontakter for vekslestrømmens udgangskredsløb forsynes af andre.

## ADVARSEL



- Batterierne kan give risiko for elektrisk stød eller brandsår forårsaget af høj kortslutningsstrøm. Overhold gældende forsigtighedsregler. Servicing skal udføres af kvalificeret servicepersonale med kendskab til batterier og gældende forsigtighedsregler. Hold uautoriseret personale væk fra batterierne.
- Korrekt bortskaffelse af batterier er påkrævet. Overhold gældende lokale regler for bortskaffelsesprocedurer.
- Skaf dig aldrig af med batterierne ved at brænde dem. Batterierne kan eksplodere ved åben ild.

## Belangrijke Veiligheidsinstructies

### BELANGRIJKE VEILIGHEIDSINSTRUCTIES BEWAAR DEZE INSTRUCTIES

Deze handleiding bevat belangrijke instructies die u dient te volgen tijdens de installatie en het onderhoud van de UPS en de accu's. Lees alle instructies voordat u de apparatuur in bedrijf neemt en bewaar deze handleiding als naslagwerk.

## GEVAAR



Deze UPS bevat LEVENSGEVAARLIJKE ELEKTRISCHE SPANNING. Alle reparaties en onderhoud dienen UITSLUITEND DOOR ERKENDE SERVICEPERSONEEL te worden uitgevoerd. Er bevinden zich GEEN ONDERDELEN in de UPS die DOOR DE GEBRUIKER kunnen worden GEREPAREERD.

## WAARSCHUWING



- Deze UPS bevat een eigen energiebron (batterijen). De uitgangcontactdoos kan onder spanning staan, zelfs wanneer de UPS niet is aangesloten op de netspanning.
- Bij de modellen van 200–240V kan de uitgangcontactdoos onder spanning blijven staan. Als de bedrading van de ingangsspanningsbron in uw systeem loopt van fase naar aarde (zoals bij de meeste Europese systemen) dan bedraagt de spanning op de uitgangcontactdozen 0 V. Als de ingangsbedrading loopt van fase naar fase dan bedraagt de spanning op de uitgangcontactdozen 100–120V (gemeten tussen fase en aarde of tussen fase en neutraal, afhankelijk van de UPS-bedrading).

- Verwijder de ingang snoer niet of haal de stekker van de ingang snoer er niet uit terwijl de UPS aan staat. Hierdoor zou de UPS en uw aangesloten apparatuur geen aardebeveiliging meer hebben.
- Teneinde de kans op brand of elektrische schok te verminderen dient deze UPS in een gebouw met temperatuur- en vochtigheidsregeling te worden geïnstalleerd, waar geen geleidende verontreinigingen aanwezig zijn. De omgevingstemperatuur mag 40°C niet overschrijden. Niet gebruiken in de buurt van water of bij zeer hoge vochtigheid (max. 95%).
- Voor UPS systemen met vast-bedrade uitgangen, moet de overstroombeveiliging voor wisselstroom uitvoercircuit(s) door anderen worden geleverd.
- Voor UPS systemen met vast-bedrade uitgangen, moeten de juiste hoofdschakelaars voor wisselstroom uitvoercircuit(s) door anderen worden geleverd.



### OPGELET

- Batterijen leveren gevaar op voor elektrische schokken en kunnen brandwonden veroorzaken door een grote kortsluitstroom. Neem de juiste voorzorgsmaatregelen in acht. Het onderhoud moet worden uitgevoerd door bevoegde onderhoudsmonteurs die verstand hebben van accu's en op de hoogte zijn van de vereiste voorzorgsmaatregelen. Houd onbevoegden uit de buurt van de accu's.
- De batterijen moeten op de juiste wijze worden opgeruimd. Raadpleeg hiervoor uw plaatselijke voorschriften.
- Nooit batterijen in het vuur gooien. De batterijen kunnen ontploffen.

## Tärkeita turvaohjeita

### TÄRKEITÄ TURVAOHJEITA - SUOMI SÄILYTÄ NÄMÄ OHJEET

Tämä käyttöohje sisältää tärkeitä ohjeita, joita on noudatettava UPS-virtalähteen ja akkujen asennuksen ja huollon yhteydessä. Lue kaikki ohjeet ennen laitteiston käyttöä ja säilytä ohje myöhempää tarvetta varten.



### VAARA

Tämä UPS sisältää HENGENVAARALLISIA JÄNNITTEITÄ. Kaikki korjaukset ja huollot on jätettävä VAIN VALTUUTETUN HUOLTOHENKILÖN TOIMEKSI. UPS ei sisällä MITÄÄN KÄYTTÄJÄN HUOLLETTAVIA OSIA.

**VAROITUS**

- Tässä UPS-virtalähteessä on oma energianlähde (akut). Lähtövastakkeissa voi olla jännite, vaikka UPS-virtalähdettä ei ole kytketty verkkovirtaan.
- 200–240V -malleissa lähtövastakkeissa voi säilyä jännite. Jos sovelluksen tulovirtalähde on johdotettu linjasta neutraaliin (kuten useimmissa eurooppalaisissa sovelluksissa) lähtövastakkeiden jännite on 0 V. Linjasta linjaan –tulojohdotuksessa lähtövastakkeiden jännite on 100–120V (mitataan linjasta maahan tai linjasta neutraaliin, UPS-virtalähteen johdotuksesta riippuen).
- Älä poista tai irrota sisääntulojohtoa, kun UPS on kytkettynä. Tämä poistaa turvamaadoituksen UPS-laitteesta ja siihen liitetystä laitteistosta.
- Vähentääksesi tulipalon ja sähköiskun vaaraa asenna tämä UPS sisätiloihin, joissa lämpötila ja kosteus on säädettävissä ja joissa ei ole virtaa johtavia epäpuhtauksia. Ympäristön lämpötila ei saa ylittää 40 °C. Älä käytä lähellä vettä ja vältä kosteita tiloja (95 % maksimi).
- UPS-järjestelmissä kiintealla asennuksella: kuormana olevien laitteiden ylivirtasuojaus ja erotuskytkimet tulee toteuttaa kuormapiireissa.

**VARO**

- Akut voivat aiheuttaa sähköiskun tai palovammojen vaaran johtuen suuresta oikosulkuvirrasta. Noudata kaikkia asianmukaisia varoituksia. Laitteen saa huoltaa vain ammattitaitoinen huoltohenkilökunta, joka tuntee akut ja niihin liittyvät varoitukset. Älä päästä valtuuttamatonta henkilöstöä lähelle akkuja.
- Akusto täytyy hävittää säädösten mukaisella tavalla. Noudata paikallisia määräyksiä.
- Älä koskaan heitä akkuja tuleen. Ne voivat räjähtää.

## Consignes de sécurité

### CONSIGNES DE SÉCURITÉ IMPORTANTES CONSERVER CES INSTRUCTIONS

Cet manuel comporte des instructions importantes que vous êtes invité à suivre lors de toute procédure d'installation et de maintenance des batteries et de l'onduleur. Veuillez consulter entièrement ces instructions avant de faire fonctionner l'équipement et conserver ce manuel afin de pouvoir vous y reporter ultérieurement.

#### DANGER!



Cet onduleur contient des TENSIONS MORTELLES. Toute opération d'entretien et de réparation doit être EXCLUSIVEMENT CONFIEE A UN PERSONNEL QUALIFIE AGRÉÉ. AUCUNE PIÈCE RÉPARABLE PAR L'UTILISATEUR ne se trouve dans l'onduleur.

#### AVERTISSEMENT!



- Cet onduleur possède sa propre source d'alimentation (batteries). Il est possible que les prises de sortie soient sous tension même lorsque l'onduleur n'est pas connectée à une alimentation CA.
- En ce qui concerne les modèles 200–240 V, il est possible que les prises de sortie restent sous tension. Si la source d'alimentation de votre application est câblée phase et neutre (comme dans la majorité des applications européennes), la tension vers les prises de sortie est de 0 V. Avec un câblage d'entrée phase à phase, la tension vers les prises de sortie est de 100–120 V (mesurée entre phase et terre ou phase et neutre suivant le câblage de l'onduleur).
- Ne pas retirer le cordon d'alimentation lorsque l'onduleur est sous tension sous peine de supprimer la mise à la terre de l'onduleur et du matériel connecté.
- Pour réduire les risques d'incendie et de décharge électrique, installer l'onduleur uniquement à l'intérieur, dans un lieu dépourvu de matériaux conducteurs, où la température et l'humidité ambiantes sont contrôlées. La température ambiante ne doit pas dépasser 40 °C. Ne pas utiliser à proximité d'eau ou dans une atmosphère excessivement humide (95 % maximum).
- Pour les modèles l'onduleur ayant des sorties câblées, la protection contre une surintensité pour le(s) circuit(s) de sortie de courant alternatif doit être fournie par un autre fournisseur.
- Pour les modèles l'onduleur ayant des sorties câblées, les interrupteurs de déconnexion convenables pour le(s) circuit(s) de sortie de courant alternatif doivent être fournis par un autre fournisseur.



## ATTENTION!

- Les batteries peuvent présenter un risque de choc électrique ou de brûlure provenant d'un courant de court-circuit haute intensité. Observez les précautions appropriées. L'entretien doit être réalisé par du personnel qualifié connaissant bien les batteries et les précautions nécessaires. N'autorisez aucun personnel non qualifié à manipuler les batteries.
- Une mise au rebut réglementaire des batteries est obligatoire. Consulter les règlements en vigueur dans votre localité.
- Ne jamais jeter les batteries au feu. L'exposition aux flammes risque de les faire exploser.

## Sicherheitswarnungen

### WICHTIGE SICHERHEITSANWEISUNGEN AUFBEWAHREN

Dieses Handbuch enthält wichtige Anweisungen, die Sie während der Installation und Wartung des USV (Unterbrechungsfreies Stromversorgungssystem) und der Batterien befolgen müssen. Bitte lesen Sie alle Anweisungen des Handbuches bevor Sie mit dem Gerät arbeiten. Bewahren Sie das Handbuch zum Nachlesen auf.



## WARNUNG

Die USV führt lebensgefährliche Spannungen. Alle Reparatur- und Wartungsarbeiten sollten nur von Kundendienstfachleuten durchgeführt werden. Die USV enthält keine vom Benutzer zu wartenden Komponenten.



## ACHTUNG

- Diese USV (Unterbrechungsfreies Stromversorgung) enthält eine eigene Energiequelle (Batterien). Die Ausgangssteckdosen können Spannung führen, auch wenn die USV nicht an eine Wechselstromquelle angeschlossen ist.
- Bei Modellen mit 220–240 Volt können die Ausgangssteckverbinder stromführend bleiben. Wenn die Eingangsstromquelle in Ihrer Anlage mit Masseleitung verkabelt ist (wie in den meisten europäischen Anlagen), beträgt die Spannung an den Ausgangssteckverbindern 0 Volt. Bei einer Verkabelung mit Außenleitern beträgt die Spannung an den Ausgangssteckverbindern 110–120 Volt (gemessen von Leitung zu Masse oder Leitung zu Masseleiter, abhängig von der USV-Verkabelung).
- Das Eingangskabel nicht entfernen oder abziehen, während die USV eingeschaltet ist, weil hierdurch die Sicherheitserdung von der USV und den daran angeschlossenen Geräten entfernt wird.

- Um die Brand- oder Elektroschockgefahr zu verringern, diese USV nur in Gebäuden mit kontrollierter Temperatur und Luftfeuchtigkeit installieren, in denen keine leitenden Schmutzstoffe vorhanden sind. Die Umgebungstemperatur darf 40°C nicht übersteigen. Die USV nicht in der Nähe von Wasser oder in extrem hoher Luftfeuchtigkeit (max. 95 %) betreiben.
- Für USV-Systeme mit festverdrahteten Eingängen muß der Überstromschutz für die Ausgangswechselstromkreise anderweitig bereitgestellt werden.
- Für USV-Systeme mit festverdrahteten Ausgängen müssen Trennschalter für die Ausgangswechselstromkreise mit passendem Nennwert anderweitig bereitgestellt werden.



### VORSICHT!

- Batterien können das Risiko eines elektrischen Schlags bergen oder durch hohen Kurzschlussstrom in Brand geraten. Die richtigen Vorsichtsmaßnahmen beachten. Wartungsarbeiten müssen von qualifizierten Kundendienstfachleuten durchgeführt werden, die Kenntnisse über Akkus besitzen und die erforderlichen Vorsichtsmaßnahmen beachten. Unberechtigtes Personal von den Akkus fern halten.
- Ordnungsgemäße Entsorgung der Akkus ist erforderlich. Lesen Sie hierfür Ihre örtlichen Entsorgungsbestimmungen.
- Die Akkus nicht in einem Feuer entsorgen. In Feuer können Akkus explodieren.

## Avvisi di sicurezza

### IMPORTANTI ISTRUZIONI DI SICUREZZA CONSERVARE QUESTE ISTRUZIONI

Il presente manuale contiene importanti istruzioni da seguire durante l'installazione e la manutenzione dell'UPS e delle batterie. Leggere integralmente le istruzioni prima di utilizzare l'apparecchiatura e conservare il presente manuale per futuro riferimento.



### PERICOLO

La TENSIONE contenuta in questo gruppo statico di continuità è LETALE. Tutte le operazioni di riparazione e di manutenzione devono essere effettuate ESCLUSIVAMENTE DA PERSONALE TECNICO AUTORIZZATO. All'interno del gruppo statico di continuità NON vi sono PARTI RIPARABILI DALL'UTENTE.





## AVVERTENZA

- L'UPS contiene la propria fonte di energia (batterie). Le prese d'uscita possono essere sotto tensione anche quando l'UPS non è collegato all'alimentazione elettrica CA.
- Nei modelli da 200–240 V è possibile che le prese d'uscita rimangano sotto tensione. Se la fonte di alimentazione in entrata dell'installazione è costituita da un collegamento linea-neutro (come accade nella maggior parte delle installazioni europee), la tensione delle prese d'uscita è pari a 0 V. Con un cablaggio in entrata del tipo linea-linea, la tensione sulle prese d'uscita è 100–120 V (con misurazione effettuata da linea a terra o da linea a neutro in base al cablaggio dell'UPS).
- Non rimuovere nè scollegare il cavo di ingresso quando il gruppo statico di continuità è acceso poichè in tal modo si disattiverebbe il collegamento a terra di sicurezza del gruppo statico di continuità e dell'apparecchiatura ad esso collegata.
- Per ridurre il rischio di incendio o di scossa elettrica, installare il gruppo statico di continuità in un ambiente interno a temperatura ed umidità controllata, privo di agenti contaminanti conduttivi. La temperatura ambiente non deve superare i 40°C. Non utilizzare l'unità in prossimità di acqua o in presenza di umidità eccessiva (95% max).
- Nei sistemi UPS provvisti di uscite cablate, i dispositivi di protezione da sovracorrente per il/i circuito/i a corrente alternata in uscita devono essere forniti da terzi.
- Nei sistemi UPS provvisti di uscite cablate, i sezionatori di corrente nominale adeguata per il/i circuito/i a corrente alternata in uscita devono essere forniti da terzi.



## ATTENZIONE

- Le batterie possono comportare un rischio di scossa elettrica o di ustione in seguito a un'elevata corrente di corto circuito. Osservare le dovute precauzioni. L'assistenza deve essere eseguita da personale qualificato esperto di batterie e delle necessarie precauzioni. Tenere il personale non autorizzato lontano dalle batterie.
- Le batterie devono essere smaltite in modo corretto. Per i requisiti di smaltimento fare riferimento alle disposizioni locali.
- Non gettare mai le batterie nel fuoco poichè potrebbero esplodere se esposte alle fiamme.

## Viktig Sikkerhetsinformasjon

### VIKTIGE SIKKERHETSINSTRUKSJONER GJEM DISSE INSTRUKSJONENE

Denne håndboken inneholder viktige instruksjoner som du bør overholde ved montering og vedlikehold av UPS-enheten og batteriene. Les alle instruksjoner før utstyret tas i bruk, og gjem håndboken til fremtidig referanse.



#### FARLIG

Denne UPS'en inneholder LIVSFARLIGE SPENNINGER. All reparasjon og service må kun utføres av AUTORISERT SERVICEPERSONALE. BRUKERE KAN IKKE UTFØRE SERVICE PÅ NOEN AV DELENE i UPS'en.



#### FARLIG

- UPS-enheten inneholder sin egen energikilde (batterier). Utgangsstikkene kan være strømførende selv når UPS-enheten ikke er koblet til et strømuttak.
- Utgangsstikkene kan være strømførende for 200–240V modellene. Spenningen til utgangsstikkene vil være 0 V dersom din enhets strømkilde er fase-til-nøytral (som på de fleste europeiske enheter). Med ledningsført fase-til-fase inngang vil spenningen til utgangsstikkene være 100–120V (målt fra fase-til-jord eller fase-til-nøytral, avhengig av UPS-ledningsføringen).
- Strømforsyningskabelen må ikke fjernes eller trekkes ut når UPS'en er på, slik at ikke sikkerhetsjordingen fjernes fra UPS'en og det utstyret som er forbundet med den.
- For å redusere fare for brann eller elektriske støt, bør denne UPS'en installeres i et innendørs miljø med kontrollert temperatur og luftfuktighet som er fritt for ledende, forurensende stoffer. Romtemperaturen må ikke overskride 40°C. Den må ikke brukes i nærheten av vann eller ved meget høy luftfuktighet (95% maks.).
- For UPS systemer med fastkoblede uttak, må overstrømvern for vekselstrømuttak(ene) stilles til rådighet av andre.
- For UPS systemer med fastkoblede uttak, må passende utkoplingsbrytere for vekselstrømuttak(ene) stilles til rådighet av andre.



## FORSIKTIG

- Batterier kan utgjøre en fare for elektrisk støt eller brannskår pga. høy kortslutningsstrøm. Treff passende forholdsregler. Service bør utføres av kvalifisert servicepersonale med kjennskap til batterier og nødvendige forholdsregler. Hold uautorisert personale borte fra batteriene.
- Batterier må fjernes på korrekt måte. Se lokale forskrifter vedrørende krav om fjerning av batterier.
- Kast aldri batterier i flammer, da de kan eksplodere, hvis de utsettes for åpen ild.

## Regulamentos de Segurança

### INSTRUÇÕES DE SEGURANÇA IMPORTANTES GUARDE ESTAS INSTRUÇÕES

Este manual contém instruções importantes que devem ser seguidas durante a instalação e manutenção do no-break e das baterias. Leia todas as instruções antes de operar o equipamento e guarde este manual para consultá-lo futuramente.



## CUIDADO

A UPS contém VOLTAGEM MORTAL. Todos os reparos e assistência técnica devem ser executados **SOMENTE POR PESSOAL DA ASSISTÊNCIA TÉCNICA AUTORIZADO**. Não há nenhuma PEÇA QUE POSSA SER REPARADA PELO USUÁRIO dentro da UPS.



## ADVERTÊNCIA

- Este no-break possui sua própria fonte de energia (baterias). As tomadas de saída podem estar energizadas mesmo que o no-break não esteja conectado a uma fonte de energia elétrica.
- Nos modelos 200–240V, pode ser que as tomadas de saída permaneçam energizadas. Se a alimentação da sua aplicação for do tipo fase-neutro (como ocorre na maioria das aplicações na Europa), a tensão das tomadas de saída é de 0 V. Com a alimentação fase-fase, a tensão das tomadas de saída é de 100–120V (medida como fase-terra ou fase-neutro, dependendo da instalação elétrica do no-break).
- Não remova ou desconecte o cabo de entrada quando a UPS estiver ligada. Isto removerá o aterramento de segurança da UPS e do equipamento conectado.
- Para reduzir o risco de incêndios ou choques elétricos, instale a UPS em ambiente interno com temperatura e umidade controladas e livres de contaminadores condutíveis. A temperatura ambiente não deve exceder 40°C. Não opere próximo a água ou em umidade excessiva (máx: 95%).

- Para sistemas UPS com saídas conectadas, a proteção de sobrecarga para circuitos de saída de corrente alternada deve ser fornecida por outros.
- Para sistemas UPS com saídas conectadas, interruptores de desconexão devidamente qualificados para circuitos de saída de corrente alternada devem ser fornecidos por outros.



## PERIGO

- As baterias podem oferecer risco de choque elétrico ou queimadura, ocasionados por alta tensão com possibilidade de curto-circuito. Tome as precauções adequadas. A manutenção deve ser realizada por pessoal qualificado, com conhecimento sobre baterias e ciente das precauções exigidas. Mantenha o pessoal não autorizado afastado das baterias.
- Siga as instruções apropriadas ao desfazer-se das baterias. Consulte os códigos do local para maiores informações sobre os regulamentos de descarte de produtos.
- Nunca jogue as baterias no fogo, porque há risco de explosão.

## Меры безопасности

### ВАЖНЫЕ УКАЗАНИЯ ПО МЕРАМ БЕЗОПАСНОСТИ СОХРАНИТЕ ЭТИ УКАЗАНИЯ

В данном руководстве содержатся важные инструкции по установке и обслуживанию источника бесперебойного питания (ИБП) и батарей. Перед работой с оборудованием прочтите все инструкции. Сохраните данное руководство для дальнейшего использования.



## ОПАСНО

В данном ИБП имеются СМЕРТЕЛЬНО ОПАСНЫЕ НАПРЯЖЕНИЯ. Все работы по ремонту и обслуживанию должны выполняться ТОЛЬКО УПОЛНОМОЧЕННЫМ ОБСЛУЖИВАЮЩИМ ПЕРСОНАЛОМ. Внутри ИБП нет узлов, ОБСЛУЖИВАЕМЫХ ПОЛЬЗОВАТЕЛЕМ.



## ПРЕДУПРЕЖДЕНИЕ

- В данном ИБП установлены собственные источники энергии (батареи). На выходных розетках может быть напряжение, даже если ИБП не подключен к сети переменного тока.
- На выходных розетках моделей с напряжением 200-240 В может быть напряжение. Если устройство рассчитано на тип подключения “фаза-нейтраль” (как большинство устройств, изготавливаемых в Европе), напряжение на выходных розетках равно 0 В. При типе подключения “фаза-фаза” напряжение на выходных розетках составляет 100-120 В (при измерении “фаза-земля” или “фаза-нейтраль”, в зависимости от электрической схемы ИБП).
- Не отсоединяйте сетевой шнур и не извлекайте его вилку из розетки при включенном ИБП. При этом защитное заземление отключается от ИБП и от оборудования, подключенного к ИБП.
- Для снижения опасности пожара или поражения электрическим током устанавливайте ИБП в закрытом помещении с контролируемыми температурой и влажностью, в котором отсутствуют проводящие загрязняющие вещества. Температура окружающего воздуха не должна превышать 40°C. Не эксплуатируйте устройство около воды или в местах повышенной влажности (макс. 95%).
- Для моделей ИБП с постоянно запаянными выходными контактами устройство защиты от перегрузки выходного контура (контуров) переменного тока приобретается отдельно.
- Для моделей ИБП с постоянно запаянными выходными контактами соответствующие размыкающие переключатели выходного контура (контуров) переменного тока приобретаются отдельно.



## ОСТОРОЖНО

- Высокое напряжение, вызванное коротким замыканием в батарее, может привести к поражению электрическим током или ожогу. Соблюдайте меры предосторожности. Техническое обслуживание должно осуществляться квалифицированным персоналом по работе с источниками питания, знакомым с мерами предосторожности. Не допускайте к работе с батареями посторонних.
- Необходимо соблюдать правила утилизации аккумуляторов. Обратитесь к местным нормативным актам за информацией о требованиях к утилизации.
- Никогда не бросайте батареи в огонь. Батареи могут взорваться под воздействием огня.

## Advertencias de Seguridad

### INSTRUCCIONES DE SEGURIDAD IMPORTANTES GUARDE ESTAS INSTRUCCIONES

Este manual contiene instrucciones importantes que debe seguir durante la instalación y el mantenimiento del SAI y de las baterías. Por favor, lea todas las instrucciones antes de poner en funcionamiento el equipo y guarde este manual para referencia en el futuro.

#### PELIGRO



Este SAI contiene VOLTAJES MORTALES. Todas las reparaciones y el servicio técnico deben ser efectuados SOLAMENTE POR PERSONAL DE SERVICIO TÉCNICO AUTORIZADO. No hay NINGUNA PARTE QUE EL USUARIO PUEDA REPARAR dentro del SAI.

#### ADVERTENCIA



- Este SAI contiene su propia fuente de energía (baterías). Los receptáculos de salida pueden transportar voltaje activo aun cuando el SAI no esté conectado con una fuente de CA.
- Para los modelos 200–240V, es posible que los receptáculos de salida permanezcan eléctricamente activos. Si la fuente de energía de entrada de su aplicación está cableada de línea a neutro (como la mayoría de las aplicaciones europeas), el voltaje a los receptáculos de salida es 0V. Con cableado de entrada de línea a línea, el voltaje hacia los receptáculos de salida es 100–120V (medido de línea a tierra o de línea a neutro, lo que dependerá del cableado del SAI).
- No retire o desenchufe el cable de entrada mientras el SAI se encuentre encendido. Esto suprime la descarga a tierra de seguridad del SAI y de los equipos conectados al SAI.
- Para reducir el riesgo de incendio o de choque eléctrico, instale este SAI en un lugar cubierto, con temperatura y humedad controladas, libre de contaminantes conductores. La temperatura ambiente no debe exceder los 40°C. No trabaje cerca del agua o con humedad excesiva (95% máximo).
- Para los sistemas SAI con salidas cableadas permanentemente, la protección contra exceso de corriente para el/los circuito(s) de CA de salida será suministrada por terceros.
- Para los sistemas SAI con salidas cableadas permanentemente, los interruptores de desconexión debidamente clasificados para el/los circuito(s) de CA de salida serán suministrados por terceros.



## PRECAUCIÓN

- Las baterías pueden constituir un riesgo de descarga eléctrica o quemaduras por corriente alta de corto circuito. Adopte las precauciones debidas. Personal calificado de servicio que conozca de baterías y esté al tanto de las precauciones requeridas debe darle servicio al equipo. Mantenga al personal no autorizado alejado de las baterías.
- Es necesario desechar las baterías de un modo adecuado. Consulte las normas locales para conocer los requisitos pertinentes.
- Nunca deseche las baterías en el fuego. Las baterías pueden explotar si se las expone a la llama.

## Säkerhetsföreskrifter

### VIKTIGA SÄKERHETSFÖRESKRIFTER SPARA DESSA FÖRESKRIFTER

Den här anvisningen innehåller viktiga instruktioner som du ska följa under installation och underhåll av UPS-enheten och batterierna. Läs alla instruktioner innan du använder utrustningen och spara den här anvisningen för framtida referens.



## FARA

Denna UPS-enhet innehåller LIVSFARLIG SPÄNNING. ENDAST AUKTORISERAD SERVICEPERSONAL får utföra reparationer eller service. Det finns inga delar som ANVÄNDAREN KAN UTFÖRA SERVICE PÅ inuti UPS-enheten.



## VARNING

- Den här UPS-enheten innehåller sin egen energikälla (batterier). Uttagen kan vara spänningsförande även då UPS-enheten inte är ansluten till spänningsnätet.
- På modellerna 200 – 240 V kan de utgående uttagen fortfarande vara strömförande. Om den ingående strömkällan i din applikation är kopplad ledare-till-nolla (det vanligaste i Europa) är spänningen till de utgående uttagen 0 V. Är den ingående strömkällan kopplad ledare-till-ledare är spänningen i de utgående uttagen 100–120 V (uppmätt från ledare-till-jord eller ledare-till-nolla beroende på UPS:ens anslutning).
- Ta aldrig bort nätsladden när UPS-enheten är påslagen. Detta tar bort skyddsjordningen från både UPS-enheten och den anslutna utrustningen.
- Minska risken för brand eller elektriska stötar genom att installera denna UPS-enhet inomhus, där temperatur och luftfuktighet är kontrollerade och där inga ledande föroreningar förekommer. Omgivande temperatur får ej överstiga 40 °C. Använd inte utrustningen nära vatten eller vid hög luftfuktighet (max 95 %).

- Överströmsskydd för de utgående växelströmskretsarna ska tillhandahållas av andra för UPS-system med fasta utgångar.
  - Bortkopplingsswitchar med passande dimensionering för de utgående växelströmskretsarna ska tillhandahållas av andra för UPS-system med fasta utgångar.
- 



## VIKTIGT

- Batterierna kan innebära en risk för elektrisk stöt eller brännskada från kortsloten starkström. Iakttag lämpliga försiktighetsåtgärder. Service ska utföras av utbildad servicepersonal med kunskap om batterierna och nödvändiga försiktighetsåtgärder. Håll ej behörig personal borta från batterierna.
  - Batterierna måste avyttras enligt anvisningarna i lokal lagstiftning.
  - Använda batterier får aldrig brännas upp. De kan explodera.
-



## Chapter 3 Installation

This section explains:

- Equipment inspection
- Rail kit installation
- UPS installation, including internal batteries
- Extended Battery Module (EBM) installation
- Remote emergency power-off (REPO) installation

### Inspecting the Equipment

If any equipment has been damaged during shipment, keep the shipping cartons and packing materials for the carrier or place of purchase and file a claim for shipping damage. If you discover damage after acceptance, file a claim for concealed damage.

To file a claim for shipping damage or concealed damage: 1) File with the carrier within 15 days of receipt of the equipment; 2) Send a copy of the damage claim within 15 days to your service representative.

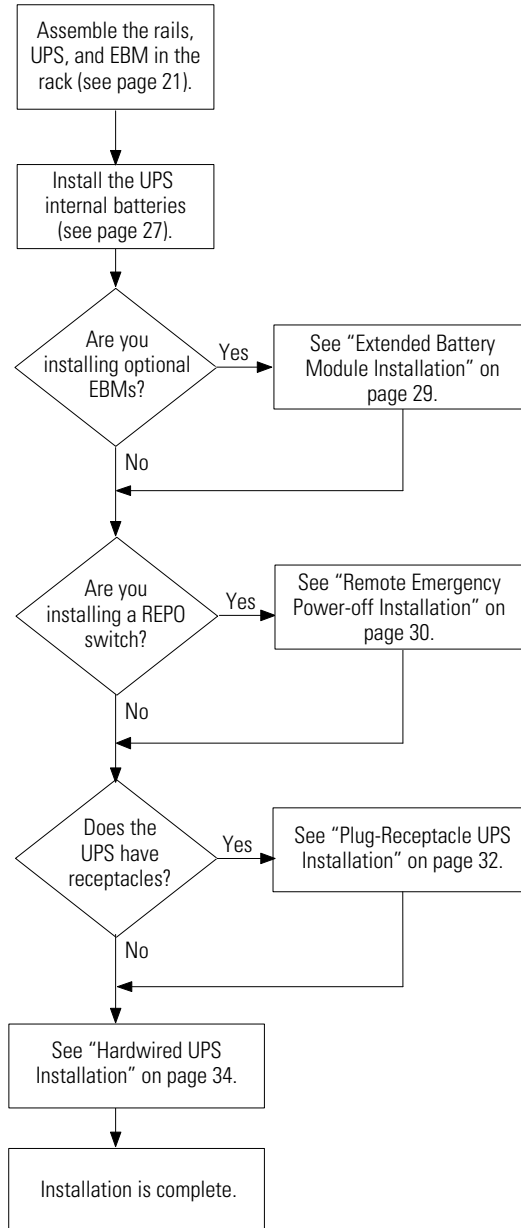


---

**NOTE** Check the battery recharge date on the shipping carton label. If the date has expired and the batteries were never recharged, do not use the UPS. Contact your service representative.

---

## Installation Overview



## Installing the Rail Kit

The rail kit can be mounted in 48-cm (19-inch) panel racks from 61 to 76 cm (24 to 30 inches) deep and includes:

- Left and right adjustable rail assemblies
- Two rear hold-down brackets
- Two mounting brackets
- Four U-shaped #10-32 clip nuts
- Twelve hex-head screws
- Four #6-32 × 3/8" flat-head screws

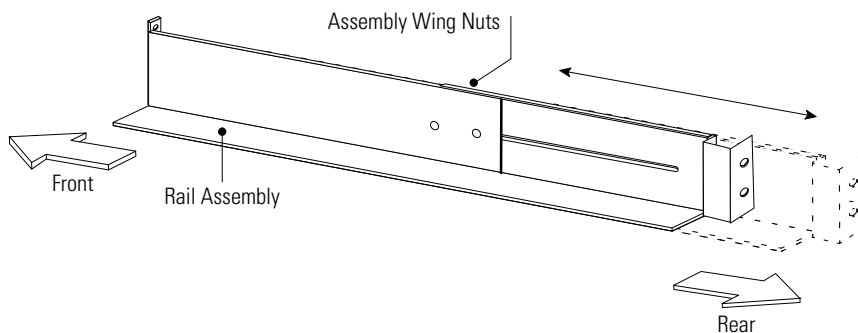


**NOTE** Mounting rails are required for each individual cabinet.

**NOTE** If placed in a rack with existing equipment, the rack must be reconfigured to install the heaviest item in the bottom of the rack. See page 62 for UPS and EBM weights.

To install the rail kit:

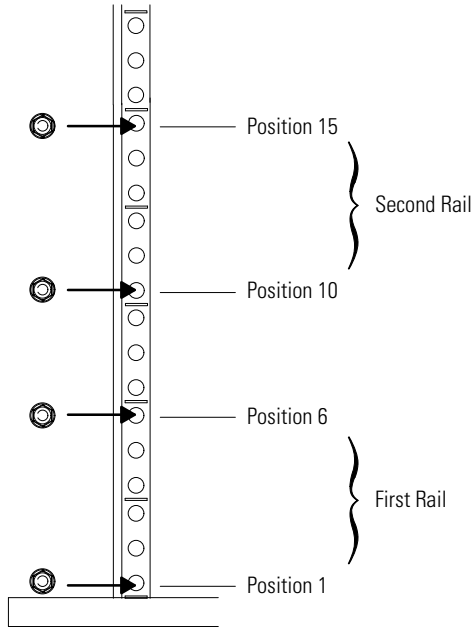
1. Loosen the assembly wing nuts on both rail assemblies and adjust the rail size for the depth of your rack (see Figure 2).



**Figure 2. Adjusting the Rail Depth**

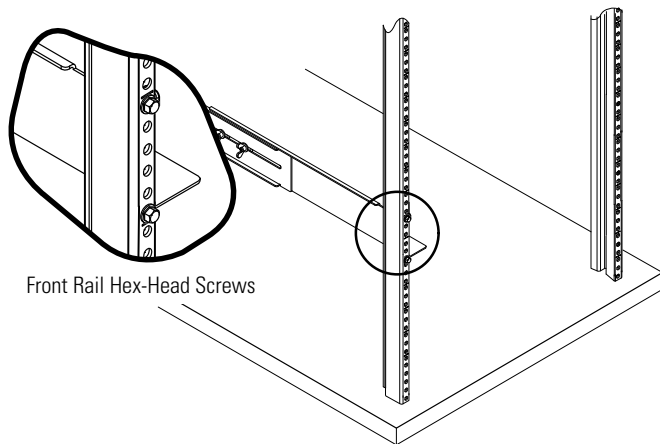
2. Select the proper holes in the rail for positioning the UPS and any optional cabinets in the rack (see Figure 3).

The first rail should be placed at the bottom, using positions 1 and 6 for the front rail hex-head screws. If you are installing additional rails, the next rail should be placed 4 holes above the last installed screw.



**Figure 3. Front Rail Screw Positions**

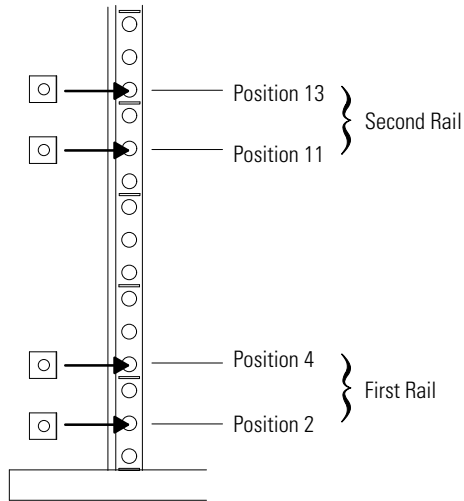
3. Secure the rail to the front of the rack with two hex-head screws (see Figure 4).



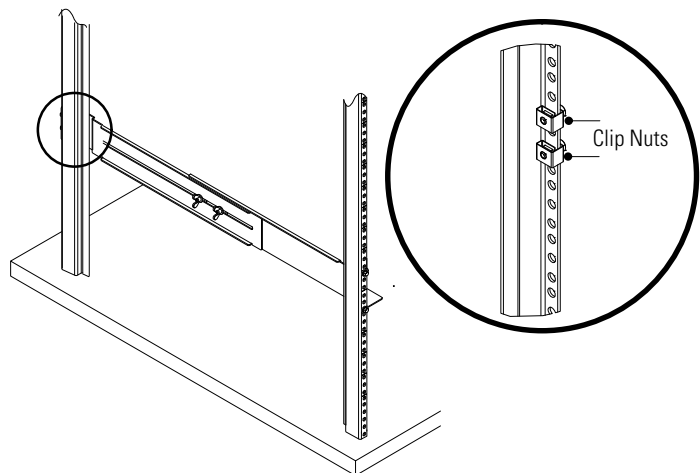
**Figure 4. Securing the Front Rail**

4. Using two clip nuts and two hex-head screws, attach the rail to the rear of the rack (see Figure 5 and Figure 6).

The bottom rail uses positions 2 and 4 for the rear hex-head screws. If you are installing additional rails, the next rail should be placed 7 holes above the last installed screw.

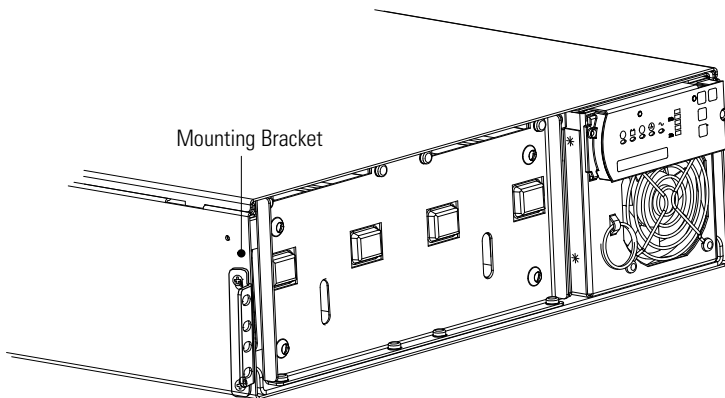


**Figure 5. Rear Rail Screw Positions**



**Figure 6. Securing the Rear Rail**

5. Repeat Steps 3 and 4 for the other rail.
6. Tighten the assembly wing nuts on both rail assemblies.
7. Place the UPS on a flat, stable surface with the front of the UPS facing toward you.
8. Align the mounting brackets with the screw holes on the sides of the UPS and secure with the supplied #6-32 × 3/8" flat-head screws (see Figure 7).
9. If installing optional EBMs, repeat Steps 7 and 8 for each cabinet.



**Figure 7. Installing the Mounting Brackets**

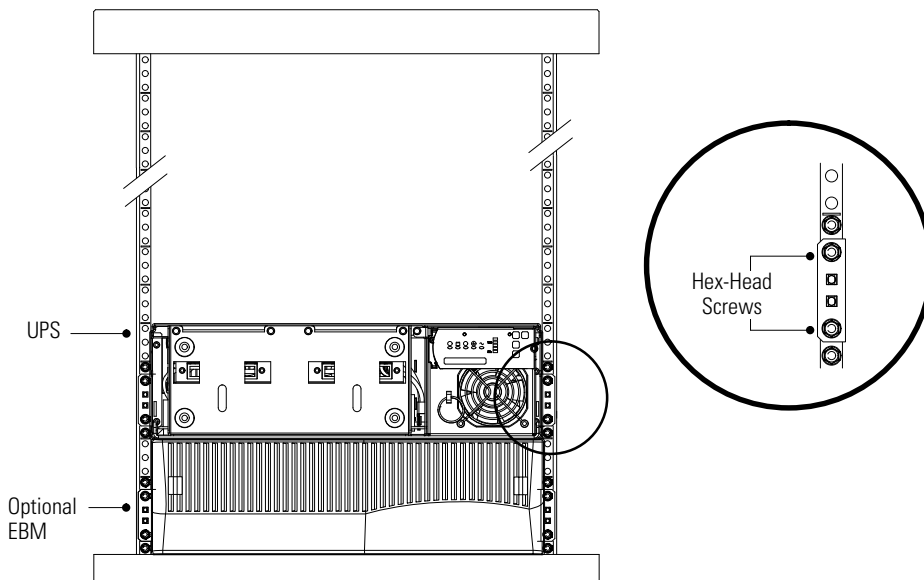
**CAUTION**

The UPS and EBM are heavy (see page 62). A minimum of two people are required to lift the cabinets into the rack.



**NOTE** The EBMs must be installed below the UPS as shown in Figure 8.

10. Slide the UPS and any optional EBMs into the rack.
11. Secure the front of the cabinet to the rack using two hex-head screws in the top and bottom positions of each mounting bracket (see Figure 8). Repeat for each cabinet.

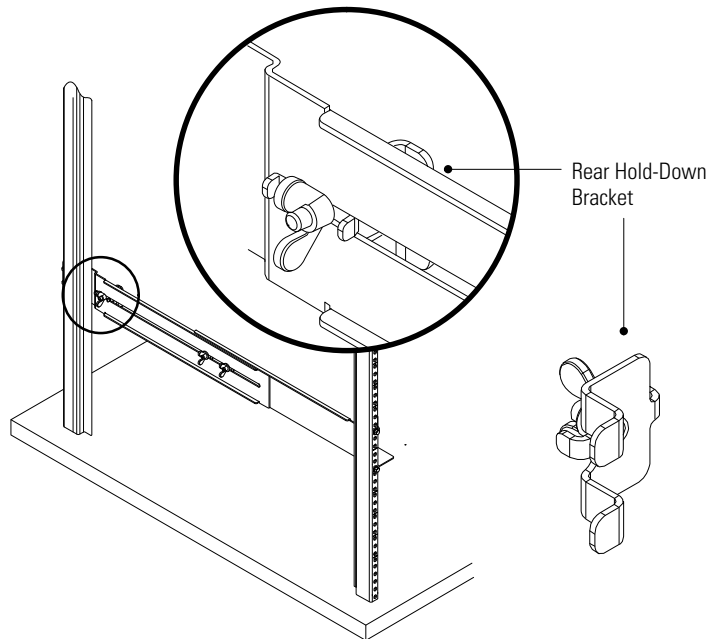


**Figure 8. Securing the Mounting Brackets**

12. Attach the rear hold-down bracket to the rail and slide the bracket into the slots on the UPS rear panel. Repeat for the other side.

Verify each rear hold-down bracket is fully seated and then tighten the wing nut. The UPS is now secured in the rack.

13. If installing optional EBMs, repeat Step 12 for each cabinet.



**Figure 9. Securing the Back of the UPS**

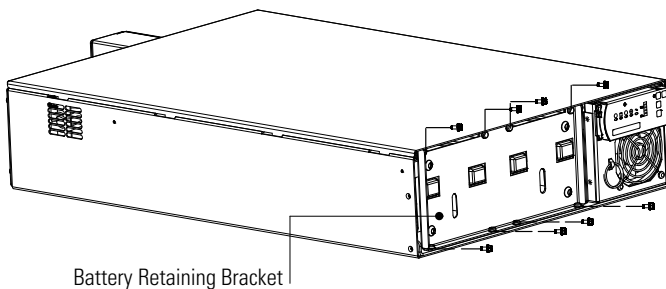
14. Continue to the following section, "Installing the UPS Internal Batteries."



## Installing the UPS Internal Batteries

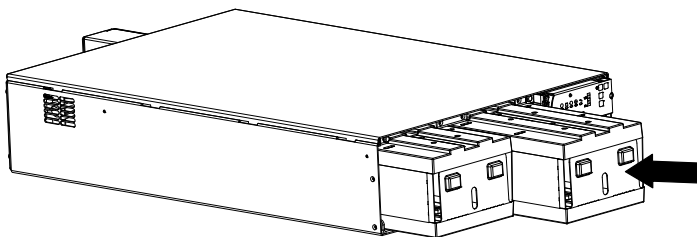
To install the battery trays into the UPS chassis:

1. Verify that the battery circuit breaker on the UPS rear panel is in the OFF position (see Figure 13 on page 29).
2. Unscrew and set aside the battery retaining bracket (see Figure 10).



**Figure 10. Battery Retaining Bracket**

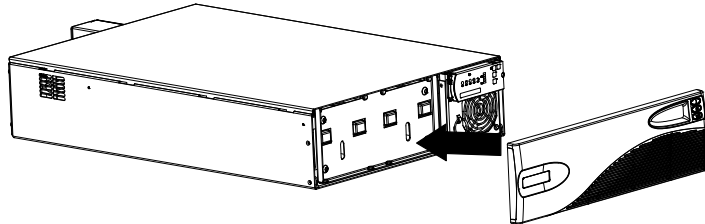
3. Slide the left battery tray into the chassis. Repeat for the right battery tray.



**Figure 11. Installing the Battery Trays**

4. Secure the battery trays to the chassis with the battery retaining bracket and screws removed in Step 2.

5. Align the UPS front cover (provided in the accessory kit) with the right retaining hook and front cover holes on the UPS cabinet. Insert the UPS front cover.



**Figure 12. Installing the UPS Front Cover**

6. If you are installing an optional Extended Battery Module, continue to the following section, "Extended Battery Module Installation;" otherwise, continue to "Plug-Receptacle UPS Installation" on page 32 or "Hardwired UPS Installation" on page 34.

## Extended Battery Module Installation

### CAUTION



A small amount of arcing may occur when connecting an EBM to the UPS. This is normal and will not harm personnel. Insert the EBM cable into the UPS battery connector quickly and firmly.

To install the optional EBM(s):

1. Verify that all battery circuit breakers are in the OFF position (see Figure 13).
2. Plug the EBM cable(s) into the battery connector(s) as shown in Figure 13. Up to four EBMs may be connected to the UPS.
3. If you are installing an optional REPO switch, continue to the following section, "Remote Emergency Power-off Installation."

Otherwise, continue to "Plug-Receptacle UPS Installation" on page 32 or "Hardwired UPS Installation" on page 34.



**NOTE** After UPS installation, ensure maximum battery runtime by configuring the UPS for the correct number of EBMs (see page 43).

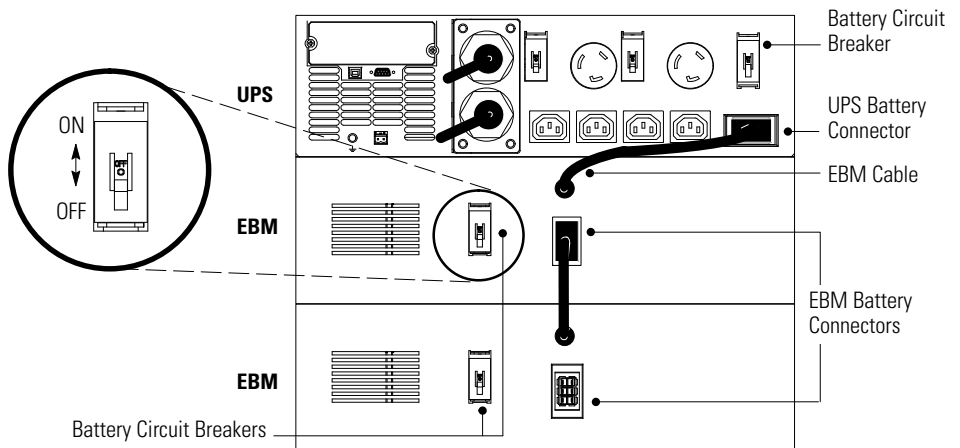



Figure 13. Typical EBM Installation (PW5125 5000 UPS Model Shown)

## Remote Emergency Power-off Installation

The Eaton 5125 includes a REPO port that allows power to be switched off at the UPS output from a customer-supplied switch in a remote location.

The REPO feature shuts down the protected equipment immediately and does not follow the orderly shutdown procedure initiated by any power management software. Any devices that are operating on battery power are also shut down immediately.

The UPS does not automatically restart when the REPO switch is reset; the UPS must be manually restarted.

If the Off  button is pressed after the REPO is activated, the UPS remains in Standby mode when restarted until the On | button is pressed.

### WARNING



The REPO circuit is an IEC 60950 safety extra low voltage (SELV) circuit. This circuit must be separated from any hazardous voltage circuits by reinforced insulation.

### CAUTION



To ensure the UPS stops supplying power to the load during any mode of operation, the input power must be disconnected from the UPS when the emergency power-off function is activated.



**NOTE** The REPO function activates when the REPO contacts close.

**NOTE** If the REPO function is not needed, the REPO connector must remain installed in the REPO port on the UPS rear panel.

**NOTE** For Europe, the emergency switch requirements are detailed in Harmonized document HD-384-48 S1, "Electrical Installation of the Buildings, Part 4: Protection for Safety, Chapter 46: Isolation and Switching."

To install the REPO switch:

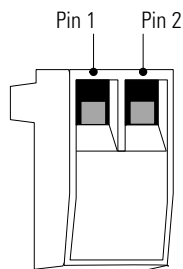
1. Verify that the UPS is off and disconnected from utility power.
2. Remove the REPO connector from the REPO port on the UPS rear panel (see Figure 14).
3. Connect isolated, normally-open, dry contacts (rated to handle 60 Vdc maximum, 30 Vac RMS maximum, and 20 mA maximum) across the REPO device to Pin 1 and Pin 2 (see Figure 14). Use stranded, non-shielded wiring, size 0.75 mm<sup>2</sup>–0.5 mm<sup>2</sup> (18–20 AWG).



---

**NOTE** A separate contact must simultaneously cause UPS input AC power to be removed.

---



**Figure 14. REPO Connector**

4. Reconnect the REPO connector to the REPO port.
5. Verify that the externally-connected REPO switch is not activated to enable power to the UPS output.

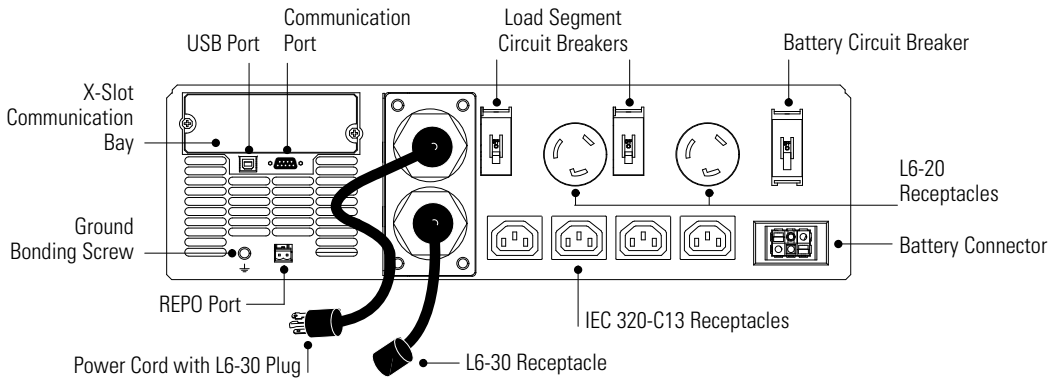
## Plug-Receptacle UPS Installation



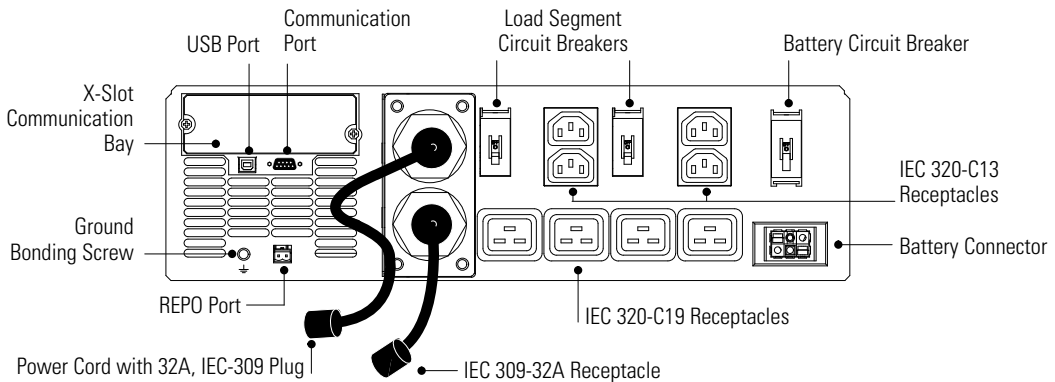
**NOTE** Do not make unauthorized changes to the UPS or accessories; otherwise, damage may occur to your equipment and void your warranty.

To install a plug-receptacle UPS:

1. If you are installing power management software, connect your computer to the USB port, UPS communication port, or optional X-Slot card (see page 47). For the communication port, use only the serial cable supplied in the accessory kit.
2. If your rack has conductors for grounding or bonding of ungrounded metal parts, connect the ground cable (not included) to the ground bonding screw.



**Figure 15. PW5125 5000 UPS Rear Panel**



**Figure 16. PW5125 6000i UPS Rear Panel**

3. Plug the equipment to be protected into the appropriate UPS output receptacles (see page 51 for more information on load segments).




---

**NOTE** *DO NOT protect laser printers with the UPS because of the exceptionally high power requirements of the heating elements.*

**NOTE** *Verify that the total equipment ratings do not exceed the UPS capacity to prevent an overload alarm.*

---

4. Verify that all load segment circuit breakers are in the ON position.
5. Remove the breaker tie from all battery circuit breakers.
6. Switch all battery circuit breakers to the ON position.
7. If an emergency power-off (disconnect) switch is required by local codes, see “Remote Emergency Power-off Installation” on page 30 to install the REPO switch before powering on the UPS.
8. Plug the UPS power cord into a power outlet.

The ~ indicator flashes, indicating the UPS is in Standby mode with the equipment offline.

9. Press and hold the On | button for approximately three seconds.

The ~ indicator illuminates solid and the load level indicators display the percentage of load being applied to the UPS. The UPS is now in Normal mode and supplying power to your equipment.

If the alarm beeps or a UPS alarm indicator stays on, see Table 10 on page 66.

To change the factory-set defaults, see “Configuration” on page 43.

10. If you installed an optional REPO, test the REPO function:

Activate the external REPO switch.

De-activate the external REPO switch and restart the UPS.

11. If optional EBMs are installed, continue to “Configuration” on page 43 to specify the number of EBMs installed.




---

**NOTE** *The batteries charge to 80% capacity in approximately 3 hours. However, it is recommended that the batteries charge for 48 hours after installation or long-term storage.*

---

## Hardwired UPS Installation



### WARNING

Only qualified service personnel (such as a licensed electrician) shall perform the electrical installation. Risk of electrical shock.

---



### CAUTION

- For UPS models with hardwired outputs, overcurrent protection for the output AC circuit(s) is to be provided by others.
  - For UPS models with hardwired outputs, suitably rated disconnect switches for the output AC circuit(s) are to be provided by others.
- 



**NOTE** *Do not make unauthorized changes to the UPS or accessories; otherwise, damage may occur to your equipment and void your warranty.*

---

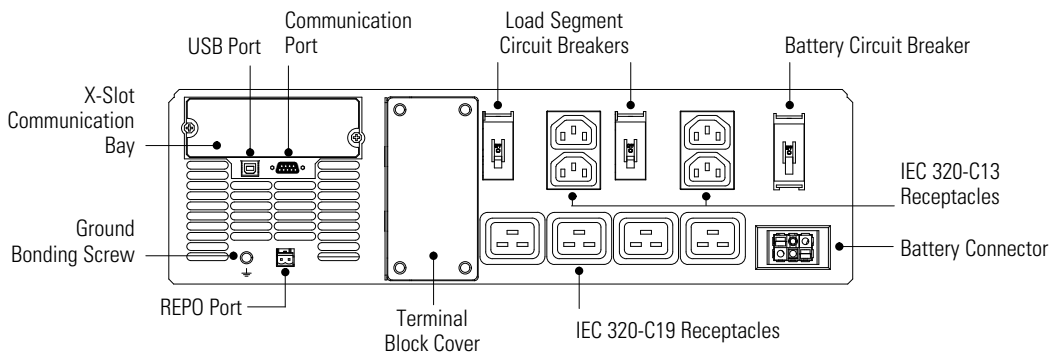
The Eaton 5125 hardwired models require a dedicated branch circuit that meets the following requirements:

- 40A minimum circuit with short circuit and overcurrent protection
- 200–240 Vac
- Single-phase
- 50/60 Hz
- The breaker must be wall-mounted and readily accessible to the operator
- Flexible metal conduit (recommended for ease of service and maintenance)



To hardwire the UPS:

1. If you are installing power management software, connect your computer to the USB port, UPS communication port, or optional X-Slot card (see page 47). For the communication port, use only the serial cable supplied in the accessory kit.
2. Switch off utility power at the distribution point where the UPS will be connected. Be absolutely sure there is no power.



**Figure 17. PW5125 6000 HW UPS Rear Panel**

3. Remove the terminal block cover and the wiring knockouts. Retain the terminal block cover.
4. Pull the input and output wires through separate conduit, leaving approximately 0.5m (2 ft) of exposed wire. Attach a flexible metal fitting to the end of each conduit.
5. Insert each conduit through a wiring access entry and attach the conduit fitting to the panel. Strip 1.5 cm (0.5") of insulation from the end of each incoming wire.
6. Connect the input and ground wires to the terminal block according to Figure 18 and Table 1.
7. Connect the output and ground wires to the terminal block according to Figure 18 and Table 1.

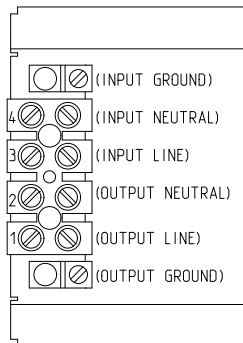


Figure 18. UPS Terminal Block

Table 1. UPS Wiring Specifications

Wire Function	Terminal Position	UPS Wire Function	Terminal Wire Size Rating*	Tightening Torque
Input	4	Input Neutral	2.5–16 mm <sup>2</sup> (14–6 AWG)	1.8 Nm (16 lb in)
	3	Input Line		
Output	2	Output Neutral	2.5–16 mm <sup>2</sup> (14–6 AWG)	1.8 Nm (16 lb in)
	1	Output Line		

\* Use 2.0 mm<sup>2</sup> (10 AWG) 75°C copper wire minimum.

8. Replace the terminal block cover.
9. If your rack has conductors for grounding or bonding of ungrounded metal parts, connect the ground cable (not included) to the ground bonding screw.
10. Plug the equipment to be protected into the appropriate UPS output receptacles (see page 51 for more information on load segments).



**NOTE** DO NOT protect laser printers with the UPS because of the exceptionally high power requirements of the heating elements.

**NOTE** Verify that the total equipment ratings do not exceed the UPS capacity to prevent an overload alarm.

11. Verify that all load segment circuit breakers are in the ON position.
12. Remove the breaker tie from all battery circuit breakers.

13. Switch all battery circuit breakers to the ON position.
14. If an emergency power-off (disconnect) switch is required by local codes, see “Remote Emergency Power-off Installation” on page 30 to install the REPO switch before powering on the UPS.
15. Switch the main utility breaker on.

The ~ indicator flashes, indicating the UPS is in Standby mode with the equipment offline.

16. Press and hold the On | button for approximately three seconds.

The ~ indicator illuminates solid and the load level indicators display the percentage of load being applied to the UPS. The UPS is now in Normal mode and supplying power to your equipment.

If the alarm beeps or a UPS alarm indicator stays on, see Table 10 on page 66.

To change the factory-set defaults, see “Configuration” on page 43.

17. If you installed an optional REPO, test the REPO function:

Activate the external REPO switch.

De-activate the external REPO switch and restart the UPS.

18. If optional EBMs are installed, continue to “Configuration” on page 43 to specify the number of EBMs installed.



---

**NOTE** *The batteries charge to 80% capacity in approximately 3 hours. However, it is recommended that the batteries charge for 48 hours after installation or long-term storage.*

---





## Chapter 4 Operation

This section describes:

- Turning the UPS on and off
- Starting the UPS on battery
- Initiating the self-test
- Operating modes

### Turning the UPS On

After the UPS is connected to utility power, it enters Standby mode (the  indicator flashes and the load level indicators are off).

To turn on the UPS, press and hold the On | button for approximately three seconds. The  indicator illuminates solid and the load level indicators display the percentage of load being applied to the UPS.



### Starting the UPS on Battery



---

**NOTE** *Before using this feature, the UPS must have been powered by utility power at least once.*


---

To turn on the UPS without using utility power, press and hold the On | button for approximately five seconds (until you hear the second beep). The UPS starts up in Battery mode and supplies battery power to your equipment. The  indicator flashes and the  indicator illuminates solid.

## Turning the UPS Off





---

**NOTE** Pressing the Off  button while the UPS is in Battery mode causes the UPS to shut down immediately.


---

To turn off the UPS:

1. Prepare your equipment for shutdown.
2. Press and hold the Off  button for approximately three seconds. The  indicator begins to flash. The UPS transfers to Standby mode (if utility power is available) and removes power from your equipment.
3. Unplug or remove utility power from the UPS; the UPS shuts down in 30 seconds. The load level and battery indicators flash briefly prior to shutdown.

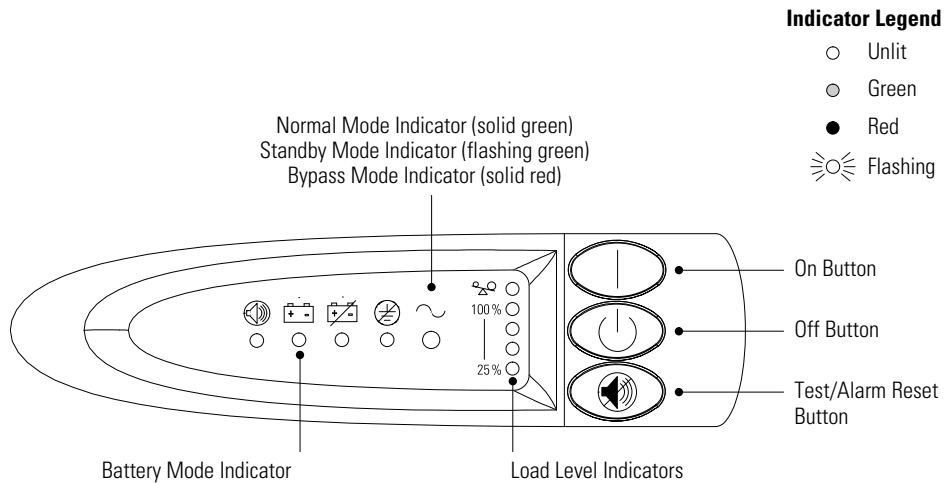
If you do not unplug or remove utility power from the UPS, it remains in Standby mode.

## Initiating the Self-Test

Press and hold the  button for three seconds to initiate the self-test. The indicators cycle through slowly during the test. If the alarm beeps or a UPS alarm indicator stays on, see Table 10 on page 66.

## Operating Modes

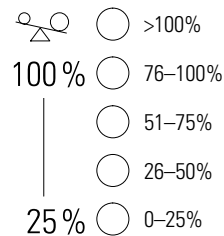
Eaton 5125's front panel indicates the UPS status through the UPS indicators. Figure 19 shows the UPS front panel indicators and controls.



**Figure 19. UPS Front Panel**

### Normal Mode



During Normal mode, the  $\sim$  indicator illuminates and the front panel displays the percentage of UPS load capacity being used by the protected equipment (see Figure 20). The UPS monitors and charges the batteries as needed and provides power protection to your equipment.




**Figure 20. Load Level Indicators**


When all of the load level indicators and the  $\Delta$ ○ indicator are illuminated, power requirements exceed UPS capacity; see page 68 for more information.

## Battery Mode


When the UPS is operating during a power outage, the alarm beeps intermittently, the  indicator illuminates, and the  indicator flashes.

When utility power returns, the UPS transfers to Normal mode operation while the battery recharges.

If battery capacity becomes low while in Battery mode, the  indicator starts flashing and the alarm becomes continuous. Immediately complete and save your work to prevent data loss and similar difficulties.


When utility power is restored after the UPS shuts down, the UPS automatically restarts. The  indicator flashes until the battery has recharged to an acceptable level.

## Bypass Mode

In the event of a UPS overload or internal failure, the UPS transfers your equipment to utility power. Battery mode is not available; however, the utility power continues to be passively filtered by the UPS. The alarm sounds and the  indicator illuminates red. The UPS transfers to Bypass mode when:

- The UPS has an overtemperature condition.
- The UPS has an overload condition of 102 to 110% for 2 minutes.
- The UPS has an overload condition >110% for 12 cycles.
- The UPS detects a fault in the UPS electronics.

## Standby Mode

When the UPS is turned off and remains connected to utility power, the UPS is in Standby mode. The  indicator flashes and the load level indicators are off, indicating that power is not available to your equipment. The battery recharges when necessary.





---

**NOTE** For 200–240V models, the output receptacles may remain electrically live (up to 100–120V). Unplug the UPS to ensure power is not available to the output receptacles.


---



## Chapter 5 Configuration

When the UPS is in Configuration mode, the front panel LEDs represent the configuration options. Use the control buttons (On | button, Off  button, and  button) to modify the UPS configuration. Figure 21 shows the LEDs and Table 2 explains the corresponding options.

To reconfigure the UPS default settings:

1. Press and hold the On | button and the  button simultaneously for three seconds. The UPS transfers to Configuration mode.

The LEDs flash briefly and then display the enabled options.



---


**NOTE** *If the LEDs start cycling automatically from left to right, repeat Step 1 and be sure to press both buttons.*

---

2. Press the On | button to scroll through the options. Each time you press the button, the UPS beeps. The LED for the selected option indicates the current setting; flashing represents disabled options (see Figure 21 and Table 2).

Scrolling past the last LED returns to the first configuration option.

If you press the On | button and nothing happens, the UPS is still in Operation mode. Repeat Step 1 to enter Configuration mode, and then perform Step 2.



3. Press the Off  button ONCE to select the Voltage or Extended Battery Module (EBM) option or to toggle the Site Wiring Fault Alarm on or off.

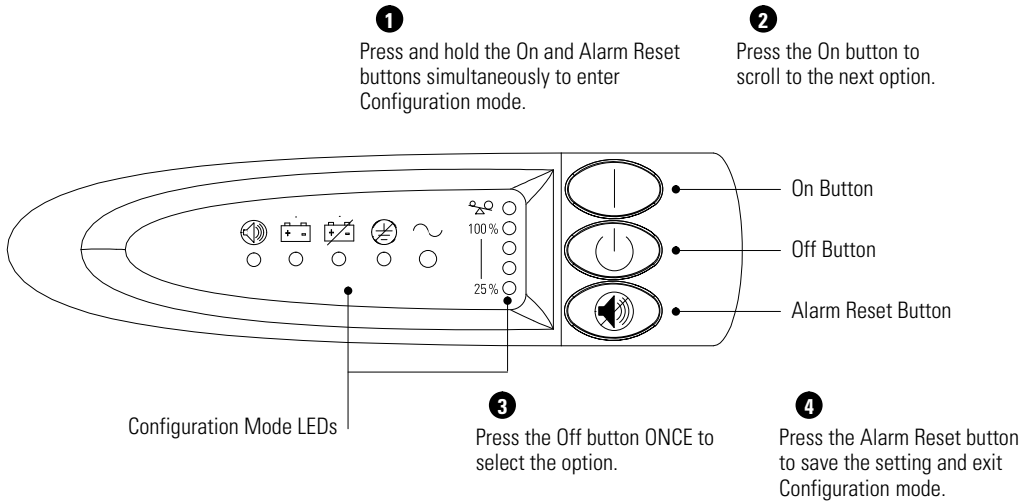


---

**NOTE** *The UPS exits Configuration mode automatically after two minutes of inactivity.*

---

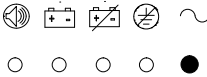




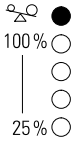
4. Press the  button to confirm the selection and exit Configuration mode. If you do not press the  button, the UPS defaults to the original settings.



**Figure 21. Using Configuration Mode**

**Table 2. Configuration Mode LEDs and Options**

Configuration Mode LEDs	Option	LED Status	Explanation
	200/208V Nominal Output Voltage	On*	Selecting this option changes the nominal output voltage to 200/208V. * Default for PW5125 5000 models.
		Flashing	200/208V is disabled; one of the other output voltage options is selected.
	220V Nominal Output Voltage	On	Selecting this option changes the nominal output voltage to 220V.
		Flashing	220V is disabled; one of the other output voltage options is selected.
	230V Nominal Output Voltage	On*	Selecting this option changes the nominal output voltage to 230V. * Default for PW5125 6000i and PW5125 6000 HW models.
		Flashing	230V is disabled; one of the other output voltage options is selected.
	240V Nominal Output Voltage	On	Selecting this option changes the nominal output voltage to 240V.
		Flashing	240V is disabled; one of the other output voltage options is selected.

Configuration Mode LEDs	Option	LED Status	Explanation
 ○ ○ ○ ○ ●	Site Wiring Fault Alarm	On	Alarm sounds when the polarity of the outlet is reversed or the ground connection is missing; have a qualified electrician repair the outlet wiring.
		Flashing (default)	Alarm DOES NOT sound when the polarity of the outlet is reversed or the ground connection is missing.
 0 EBMs	0 EBMs	On (default)	Zero EBMs are configured.
		Flashing	One of the other EBM configurations is selected.
 1 EBM	1 EBM	On	One EBM is configured.
		Flashing	One of the other EBM configurations is selected.
 2 EBMs	2 EBMs	On	Two EBMs are configured.
		Flashing	One of the other EBM configurations is selected.
 3 EBMs	3 EBMs	On	Three EBMs are configured.
		Flashing	One of the other EBM configurations is selected.
 4 EBMs	4 EBMs	On	Four EBMs are configured.
		Flashing	One of the other EBM configurations is selected.

CONFIGURATION

## Chapter 6 Additional UPS Features

This section describes the:

- USB port
- DB-9 communication port
- X-Slot cards
- Load segments

The Eaton 5125 UPS includes a USB port, a DB-9 communication port, and an X-Slot communication bay or card. Only one communication option may be used to monitor the UPS; they cannot operate simultaneously.

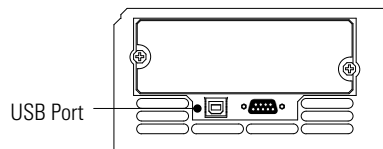
### USB Port

The UPS can communicate with a USB-compliant computer using LanSafe® Power Management Software (v5.0.1 or higher).

To establish communication between the UPS and a computer:

1. Connect the USB cable to the USB port on the UPS rear panel (see Figure 22).

Connect the other end of the USB cable to the USB port on your computer.



**Figure 22. The USB Port**

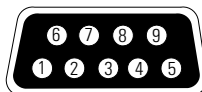
2. Install the LanSafe software and USB drivers according to the instructions provided with the Software Suite CD.

## DB-9 Communication Port

To establish communication between the UPS and a computer, connect your computer to the UPS communication port using the supplied communication cable.

When the communication cable is installed, power management software can exchange data with the UPS. The software polls the UPS for detailed information on the status of the power environment. If a power emergency occurs, the software initiates the saving of all data and an orderly shutdown of the equipment.

Figure 23 identifies the cable pins and Table 3 describes the pin functions.



**Figure 23. Communication Port**

**Table 3. Communication Port Pin Assignment**

Pin Number	Signal Name	Function	Direction from the UPS
1	Low Batt	Low Battery relay contact; 20 mA, 30 Vdc contact rating	Out
2	TxD	Transmit to external device	Out
3	RxD	Receive from external device	In
4	DTR	PnP (Plug and Play) from external device (tied to Pin 6)	In
5	GND	Signal common (tied to chassis)	—
6	DSR	To external device (tied to Pin 4)	Out
7	—	No Connection	—
8	AC Fail	AC Fail relay contact; 20 mA, 30 Vdc contact rating	Out
9	Power Source	+V (8 to 24 volts DC power)	Out

## X-Slot Cards

X-Slot cards allow the UPS to communicate in a variety of networking environments and with different types of devices.



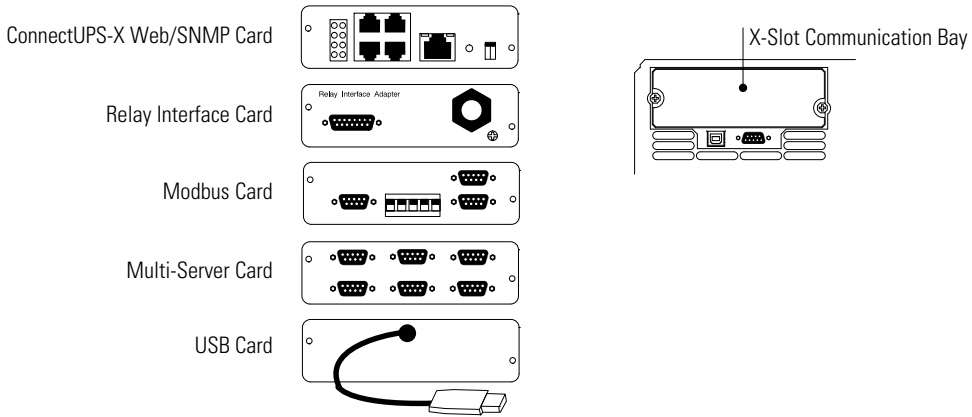
---

**NOTE** *If your UPS part number ends with -5507, your UPS includes the factory-installed ConnectUPS™-X Web/SNMP Card; continue to the following section, “The ConnectUPS-X Web/SNMP Card.”*

---

The Eaton 5125 has an available communication bay for one of the following X-Slot cards:

- ConnectUPS-X Web/SNMP Card - has SNMP and HTTP capabilities as well as monitoring through a Web browser interface; connects to a twisted-pair Ethernet (10/100BaseT) network. It has a built-in switching hub that allows three additional network devices to be connected to the network without the requirement of additional network drops. In addition, a Environmental Monitoring Probe can be attached to obtain humidity, temperature, smoke alarm, and security information.
- Relay Interface Card - has isolated dry contact (Form-C) relay outputs for UPS status: Utility failure, Low battery, UPS alarm/OK, or On bypass.
- Modbus® Card - allows you to continuously and reliably monitor the UPSs in your Building Management System (BMS).
- Multi-Server Card - has six serial communication ports that can communicate simultaneously with other computers using LanSafe Power Management Software (provided on the Software Suite CD).
- USB Card - connects to a USB port on your computer.



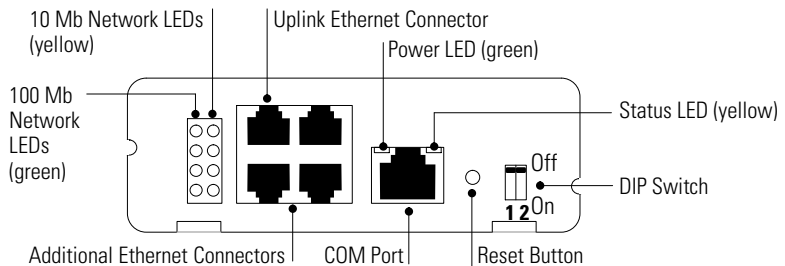
**Figure 24. Optional X-Slot Cards**

### The ConnectUPS-X Web/SNMP Card

With the ConnectUPS, you can monitor the UPS several different ways:

- Using a Web browser such as Microsoft® Internet Explorer to monitor and manage the connected UPS
- Using your Internet-ready cell phone or PDA (personal digital assistant)
- Using SNMP-compatible network management software (user-supplied) that monitors the UPS in a method similar to that of other network devices

Refer to the *ConnectUPS Web/SNMP Card User's Guide* for more information.



**Figure 25. ConnectUPS-X Panel Details**



## Load Segments

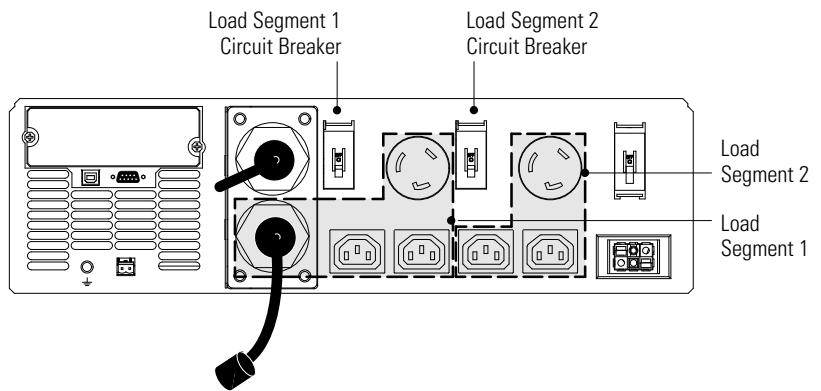
Load segments are sets of receptacles that can be controlled by power management software, providing an orderly shutdown and startup of your equipment. For example, during a power outage, you can keep key pieces of equipment running while you turn off other equipment. This feature allows you to save battery power. See your power management software manual for details (refer to the Software Suite CD or [www.eaton.com/powerquality](http://www.eaton.com/powerquality) for the latest information).



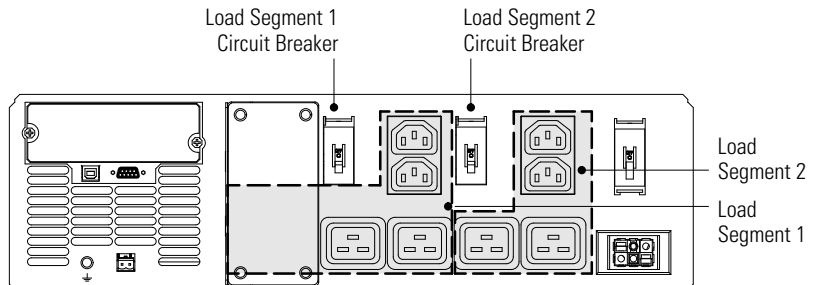
**NOTE** If power management software is not used, the individual load segments cannot be controlled.

**NOTE** The circuit breaker for Load Segment 1 does not include the corded receptacle or terminal block.

Each UPS has two load segments as shown in Figure 26 and Figure 27.



**Figure 26. UPS Load Segments (PW5125 5000 Model Shown)**



**Figure 27. UPS Load Segments (PW5125 6000 HW Shown)**

ADDITIONAL UPS FEATURES

## Chapter 7 UPS Maintenance

This section explains how to:

- Care for the UPS and batteries
- Replace the electronics module
- Replace the batteries
- Recycle used batteries or UPS

### UPS and Battery Care

For the best preventive maintenance, keep the area around the UPS clean and dust-free. If the atmosphere is very dusty, clean the outside of the system with a vacuum cleaner.

For full battery life, keep the UPS at an ambient temperature of 25°C (77°F).



---

**NOTE** *If the UPS requires any type of transportation, verify that the battery circuit breaker on the UPS rear panel is in the OFF (O) position (see Figure 31 on page 58).*

**NOTE** *The batteries in the UPS are rated for a 3–5 year service life. The length of service life varies, depending on the frequency of usage and ambient temperature. Batteries used beyond expected service life will often have severely reduced runtimes. Replace batteries at least every 5 years to keep units running at peak efficiency.*

---

### Storing the UPS and Batteries

If you store the UPS for a long period, recharge the batteries every 6 months by connecting the UPS to utility power. The batteries charge to 80% capacity in approximately 3 hours. However, it is recommended that the batteries charge for 48 hours after long-term storage.

Check the battery recharge date on the shipping carton label. If the date has expired and the batteries were never recharged, do not use the UPS. Contact your service representative.

## Replacing the Electronics Module

The electronics module can be hot-swapped for easy replacement without losing power to your equipment. The UPS automatically switches to Bypass mode. Battery mode is not available; however, the utility power continues to be passively filtered by the UPS.

If you prefer to remove input power to change the electronics module, see “Turning the UPS Off” on page 40.

To replace the electronics module:


1. Disconnect the communication cable if installed.
2. Remove the X-Slot card if installed.
3. Remove the UPS front cover by pulling on both ends (pull harder on the left side and lift the front cover off the right retaining hook).
4. Remove the screw on the left of the electronics module. Remove the electronics module and retain the screw.



---

**NOTE** To prevent power loss to your equipment, follow Step 5 closely.

---

5. While inserting the new electronics module, press and hold the  button for approximately five seconds or until the front panel indicators illuminate individually.




---

**NOTE** If the five load level indicators are flashing, the module may not be properly seated. Remove and reinsert the module as described in Step 5.

---

6. Secure the electronics module to the UPS chassis with the screw removed in Step 4.
7. Replace the UPS front cover.
8. Replace the X-Slot card if removed in Step 2.
9. Reconnect the communication cable if removed in Step 1.
10. See “Recycling the Used Battery or UPS” on page 59 for proper disposal.

## When to Replace Batteries

When the  indicator flashes and the audible alarm beeps intermittently, the batteries may need replacing. Contact your service representative to order new batteries.

## Replacing Batteries



---

**NOTE** DO NOT DISCONNECT the batteries while the UPS is in Battery mode.

---

With the hot-swappable battery feature, UPS batteries can be replaced easily without turning the UPS off or disconnecting the load.

If you prefer to remove input power to change the batteries, see “Turning the UPS Off” on page 40.

Consider all warnings, cautions, and notes before replacing batteries.

### WARNING



- Batteries can present a risk of electrical shock or burn from high short-circuit current. The following precautions should be observed: 1) Remove watches, rings, or other metal objects; 2) Use tools with insulated handles; 3) Do not lay tools or metal parts on top of batteries.
  - ELECTRIC ENERGY HAZARD. Do not attempt to alter any battery wiring or connectors. Attempting to alter wiring can cause injury.
-

## How to Replace UPS Internal Batteries

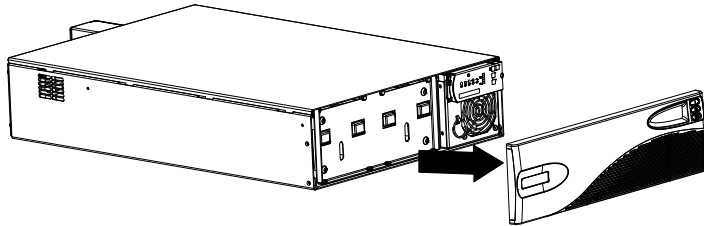
### CAUTION



- Pull the battery trays out onto a flat, stable surface. The battery trays are unsupported when you pull them out of the UPS.
- The UPS battery trays are heavy. A minimum of two people are required to lift the battery trays into the UPS chassis.

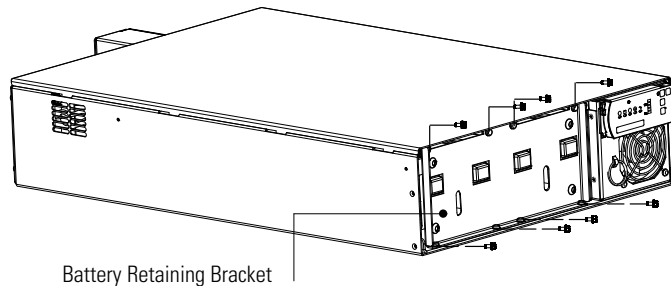
To replace the UPS internal batteries:

1. Remove the UPS front cover by pulling on both ends (pull harder on the left side and lift the front cover off the right retaining hook).



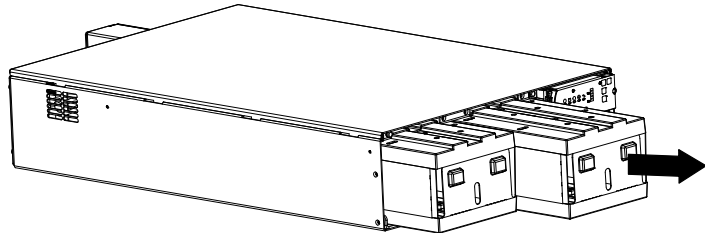
**Figure 28. Removing the UPS Front Cover**

2. Unscrew and set aside the battery retaining bracket (see Figure 29).



**Figure 29. Removing the Battery Retaining Bracket**

3. Pull the battery trays out onto a flat, stable surface. See “Recycling the Used Battery or UPS” on page 59 for proper disposal.



**Figure 30. Removing the Battery Trays**

4. Slide the left battery tray into the chassis. Repeat for the right battery tray.
5. Reinstall the battery retaining bracket removed in Step 2.
6. Replace the UPS front cover.

## How to Replace Extended Battery Modules

### CAUTION



The Extended Battery Module (EBM) is heavy (see page 62). A minimum of two people are required to lift the EBM when it is replaced.

To replace the EBMs:

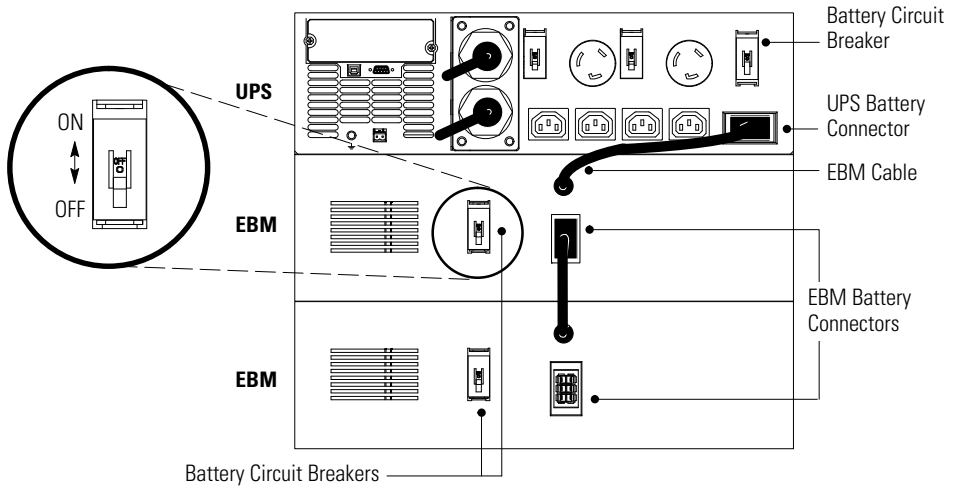
1. Switch all battery circuit breakers to the OFF position (see Figure 31).

2. Unplug the EBM cable from the UPS.

If additional EBMs are installed, unplug the EBM cable from the battery connector on each EBM.

3. Install the supplied mounting brackets on the new EBM.
4. Replace the EBM. See “Recycling the Used Battery or UPS” on page 59 for proper disposal.

5. Plug the EBM cable into the UPS as shown in Figure 31.  
 For additional EBMs, plug the EBM cable into the battery connector on the adjacent EBM.
6. Remove the breaker tie from the circuit breaker on all EBMs.
7. Switch all battery circuit breakers to the ON position.



**Figure 31. EBM Connections**



## Recycling the Used Battery or UPS

Contact your local recycling or hazardous waste center for information on proper disposal of the used battery or UPS.



### WARNING

- Do not dispose of the battery or batteries in a fire. Batteries may explode. Proper disposal of batteries is required. Refer to your local codes for disposal requirements.
- Do not open or mutilate the battery or batteries. Released electrolyte is harmful to the skin and eyes. It may be toxic.



### CAUTION

Do not discard the UPS or the UPS batteries in the trash. This product contains sealed, lead-acid batteries and must be disposed of properly. For more information, contact your local recycling/reuse or hazardous waste center.



### CAUTION

Do not discard waste electrical or electronic equipment (WEEE) in the trash. For proper disposal, contact your local recycling/reuse or hazardous waste center.



## Chapter 8 Specifications

This section provides the following specifications:

- Model list
- Electrical input and output
- Weights and dimensions
- Environmental and safety
- Battery

**Table 4. Model List**

Model Number	Power Levels (Rated at Nominal Inputs)	Input Connections	Output Connections
PW5125 5000	5000 VA, 4500W	L6-30P power cord	(1) L6-30R, (2) L6-20R, (4) 10A, IEC 320-C13
PW5125 6000i	6000 VA, 5400W	32A, IEC-309 power cord	(1) IEC 309-32A, (4) 15A, IEC 320-C19, (4) 10A, IEC 320-C13
PW5125 6000 HW		Hardwired	(4) 15A, IEC 320-C19, (4) 10A, IEC 320-C13, Hardwired

**Table 5. Electrical Input and Output**

<b>Nominal Voltage</b>	PW5125 5000 and PW5125 6000 HW: 200/208, 220, 230, 240V selectable PW5125 6000i: 220, 230, 240V selectable
<b>Voltage Range</b>	160–288V nominal
<b>Nominal Frequency</b>	50/60 Hz auto-sensing
<b>Frequency Range</b>	50 Hz: 46–54 Hz ±4% 60 Hz: 56–64 Hz ±4%
<b>Noise Filtering</b>	MOVs and line filter for normal and common mode noise
<b>Input Power Factor</b>	>0.95
<b>Regulation (Normal Mode)</b>	-10% to +6% of nominal voltage
<b>Regulation (Battery Mode)</b>	Nominal output voltage ±5%
<b>Voltage Waveform</b>	Normal mode: Sine wave; <5% THD with typical PFC load Battery mode: Sine wave; <7% THD with typical PFC load and no more than 15% at the end of battery discharge

**Table 6. Weights and Dimensions**

	<b>UPS</b>	<b>Extended Battery Module (EBM)</b>
<b>Dimensions (WxDxH)</b>	44.2 x 66 x 13 cm 17.4" x 26" x 5.1" (3U)	44.2 x 68.3 x 13 cm 17.4" x 26.9" x 5.1" (3U)
<b>Weights</b>	73 kg (161 lb)	69.9 kg (154 lb)

**Table 7. Environmental and Safety**

	PW5125 5000	PW5125 6000i	PW5125 6000 HW
<b>Operating Temperature</b>	10°C to 40°C (50°F to 104°F) Optimal battery performance: 25°C (77°F)		
<b>Storage Temperature</b>	0°C to 25°C (32°F to 77°F)		
<b>Transit Temperature</b>	-25°C to 55°C (-13°F to 131°F)		
<b>Relative Humidity</b>	5–95% noncondensing		
<b>Operating Altitude</b>	Up to 2,000 meters above sea level		
<b>Transit Altitude</b>	Up to 15,000 meters above sea level		
<b>Audible Noise</b>	Less than 45 dBA Normal mode, typical load Less than 50 dBA Battery mode		
<b>Surge Suppression</b>	ANSI C62.41 Category B3 EN 61000-4-5 Level 3, Criteria B		
<b>Safety Conformance</b>	UL 1778, CSA C22.2, No. 107.3; IEC 62040-1-1 and IEC 60950-1		
<b>Agency Markings</b>	cULus, cUL	GS, CE, GOST	
<b>EMC (Class A)</b>	IEC 62040-2, FCC Part 15, ICES-003, VCCI	IEC 62040-2, FCC Part 15, ICES-003	

**Table 8. Battery**

<b>UPS Configuration</b>	(20) 12V, 7.2 Ah internal batteries
<b>EBM Configuration</b>	EBM 240: (20) 12V, 9 Ah
<b>Type</b>	Sealed, maintenance-free, valve-regulated, lead-acid
<b>Charging</b>	Internal battery: approximately 3 hours to 80% usable capacity at nominal line voltage after full load discharge External battery: no more than 15x discharge time to 90% usable capacity at nominal line voltage after full load discharge
<b>Monitoring</b>	Advanced monitoring for earlier failure detection and warning

**Table 9. Battery Runtimes (in Minutes)**

5000 VA, 4500W Models					
Load	UPS Internal Batteries	+1 EBM	+2 EBMs	+3 EBMs	+4 EBMs
900W	59	169	303	452	612
1350W	39	108	192	284	384
1800W	26	79	138	204	274
2250W	19	61	106	156	210
2700W	15	49	85	125	168
3150W	12	41	71	104	139
3600W	9	31	60	88	118
4050W	8	27	52	76	102
4500W	7	24	46	67	89
6000 VA, 5400W Models					
Load	UPS Internal Batteries	+1 EBM	+2 EBMs	+3 EBMs	+4 EBMs
1080W	49	138	247	367	497
1620W	33	88	156	230	311
2160W	20	64	111	164	221
2700W	15	49	85	125	168
3240W	11	40	68	100	134
3780W	9	33	57	83	111
4320W	7	25	48	70	94
4860W	6	22	42	61	81
5400W	5	19	36	53	71

NOTE Battery times are approximate and vary depending on the load configuration and battery charge.

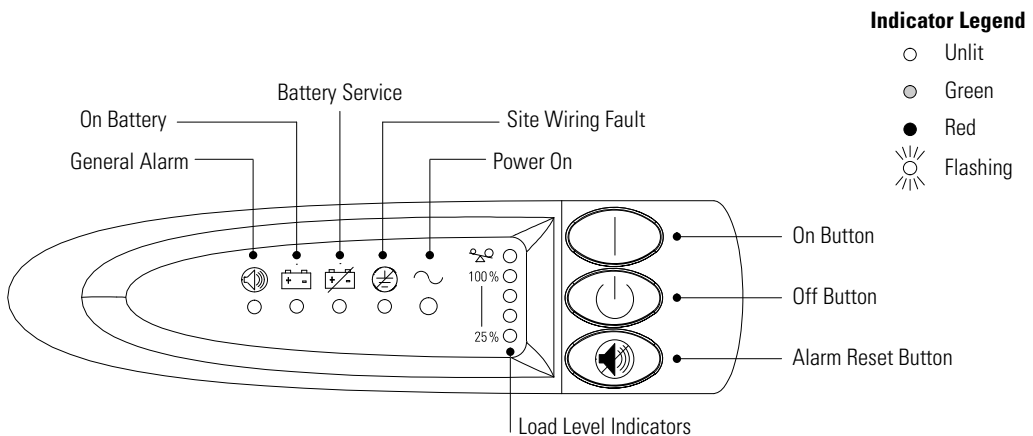
## Chapter 9 Troubleshooting

This section explains:

- UPS alarms and conditions
- How to silence an alarm
- Service and support

### Audible Alarms and UPS Conditions


The UPS has an audible alarm feature to alert you of potential power problems. Use Table 10 to determine and resolve the UPS alarms and conditions.






**Figure 32. Alarm Indicators**

### Silencing an Audible Alarm









Before silencing an alarm, check the alarm condition and perform the applicable action to resolve the condition (see Table 10).


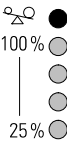

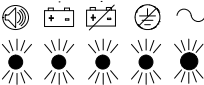
To silence the alarm for an existing fault, press the  button. If UPS status changes, the alarm beeps, overriding the previous alarm silencing.

**Table 10. Troubleshooting Guide**

<b>Alarm or Condition</b>	<b>Possible Cause</b>	<b>Action</b>
The  indicator is not on; the UPS does not start.	The power cord is not connected correctly.	Check the power cord connections.
	The wall outlet is faulty.	Have a qualified electrician test and repair the outlet.
	The main utility breaker is off.	Verify that the main utility breaker is on.
	The remote emergency power-off (REPO) switch is active.	Reset the REPO switch and restart the UPS.
	The REPO connector is missing.	Verify that the REPO connector is installed on the rear panel.
The  indicator is flashing; power is not available at the UPS output.	The UPS is in Standby mode.	Press and hold the On   button for approximately three seconds to supply power to the connected equipment.
The UPS operates normally, but some or all of the protected equipment is not on.	The equipment is not connected to the UPS correctly.	Verify that the equipment is plugged into the UPS receptacles. For hardwired models, contact a qualified electrician to check connections to the power source.
	Load segment circuit breakers are in the OFF position.	Switch load segment circuit breakers to the ON position.
	Load segments have been turned off by power management software or a communication card.	Modify the settings for Load Segment Control in the LanSafe software or the ConnectUPS-X Web/SNMP Card (refer to the individual user's guide).
The UPS does not provide the expected backup time.	The batteries need charging or service.	Plug the UPS into a power outlet (apply utility power on hardwired models) for 48 hours to charge the batteries. If the  indicator is on, see "Replacing Batteries" on page 55.
	Battery circuit breakers are in the OFF position.	Switch all the battery circuit breakers to the ON position.



Alarm or Condition	Possible Cause	Action
 Intermittent audible alarm	<p>The UPS is on battery due to a utility failure.</p> <hr/> <p>The UPS is running on battery power because the input voltage is too high or too low.</p> <hr/> <p>The utility line voltage and frequency are out of specification.</p>	<p>The UPS is powering the equipment with battery power. Prepare your equipment for shutdown.</p> <hr/> <p>The UPS continues to operate on battery until the condition is corrected or the batteries are completely discharged. If the condition persists, the input voltage in your area may differ from the UPS nominal. Change the UPS input voltage to match your local voltage; see "Configuration" on page 43.</p> <hr/> <p>Have a qualified electrician check the wiring.</p>
 Continuous audible alarm	<p>The batteries are running low.</p>	<p>Three minutes or less of battery power remains (depending on load configuration and battery charge). Save your work and turn off your equipment.</p>
 Intermittent audible alarm	<p>The batteries are not connected correctly.</p> <hr/> <p>The batteries need to be replaced.</p>	<p>Check the battery connections. Call your service representative if the problem persists.</p> <hr/> <p>Contact your service representative to order new batteries. See "Replacing Batteries" on page 55.</p>
 Intermittent audible alarm	<p>The batteries are low when the UPS starts up or returns from a utility failure.</p>	<p>The UPS is recharging the batteries. The indicator turns off when the batteries have reached an acceptable charge level. If the  or  indicator is still on after 48 hours, contact your service representative.</p>
 Intermittent audible alarm	<p>Ground wire connection does not exist or the line and neutral wires are reversed in the wall outlet.</p>	<p>Have a qualified electrician correct the wiring. To disable this alarm, see "Configuration" on page 43.</p>
 Intermittent audible alarm	<p>Bypass is out of tolerance. Input voltage is not within <math>\pm 10\%</math> of nominal.</p>	<p>The UPS is receiving utility power that may be unstable or in brownout conditions. The UPS continues to supply power to your equipment. If conditions worsen, the UPS may switch to battery power.</p>

Alarm or Condition	Possible Cause	Action
	<p>The UPS is in Bypass mode.</p>	<p>The equipment is transferred to utility power. Battery mode is not available; however, the utility power continues to be passively filtered by the UPS. Check for one of the following alarms: Overtemperature, Overload, UPS Failure, or Battery Service.</p>
	<p>Power requirements exceed UPS capacity (102 to 110% for 2 minutes or &gt;110% for 12 cycles) or the load is defective.</p>	<p>Turn off and remove utility power from the UPS. Remove some of the equipment from the UPS. Wait at least 5 seconds until all LEDs are off and restart the UPS. You may need to obtain a larger capacity UPS.</p>
 <p>Continuous audible alarm</p>	<p>The UPS internal temperature is too high. The UPS transfers to Bypass mode, allowing the UPS to cool.</p>	<p>Turn off and remove utility power from the UPS. Clear the vents and remove any heat sources. Ensure the airflow around the UPS is not restricted. Wait at least 5 minutes and restart the UPS. If the condition persists, contact your service representative.</p>
<p>Momentary overload.</p>	<p>Momentary overload.</p>	<p>The UPS transfers to Bypass mode. Repetitive overloads will lock on bypass for one hour; press the On   button for immediate return.</p>
	<p>UPS fault condition.</p>	<p>Save your work and turn off your equipment. Turn off and remove utility power from the UPS. Contact your service representative. The alarm cannot be silenced.</p>

## Service and Support

If you have any questions or problems with the UPS, call your **Local Distributor** or the **Help Desk** at one of the following telephone numbers and ask for a UPS technical representative.

United States:           **1-800-356-5737**  
Canada:                   **1-800-461-9166 ext 260**  
All other countries:   **Call your local service representative**

Please have the following information ready when you call the Help Desk:

- Model number
- Serial number
- Version number (if available)
- Date of failure or problem
- Symptoms of failure or problem
- Customer return address and contact information

If repair is required, you will be given a Returned Material Authorization (RMA) Number. This number must appear on the outside of the package and on the Bill Of Lading (if applicable). Use the original packaging or request packaging from the Help Desk or distributor. Units damaged in shipment as a result of improper packaging are not covered under warranty. A replacement or repair unit will be shipped, freight prepaid for all warrantied units.



---

**NOTE** For critical applications, immediate replacement may be available. Call the **Help Desk** for the dealer or distributor nearest you.

---



## Chapter 10 Warranty

### Two-Year Limited Warranty with Extension to Three-Year Limited Warranty (US and Canada)

#### Eaton UPS Models: 3105, 5110, 5115, 5125, and 5130

**WARRANTOR:** The warrantor for the limited warranties set forth herein is Eaton Corporation, an Ohio Corporation company ("Company").

**LIMITED WARRANTY:** This limited warranty (this "Warranty") applies only to the original End-User (the "End-User") of any Eaton 3105, 5110, 5115, 5125, and 5130 Products (individually and collectively, the "Product") purchased on or after August 19, 2009 and cannot be transferred. This Warranty applies even in the event that the Product is initially sold by Company for resale to an End-User.

**LIMITED WARRANTY PERIOD:** The period covered by this Warranty for Product installed [and currently located] in the fifty (50) United States, the District of Columbia, and Canada is twenty-four (24) months from the date of purchase, or thirty (30) months from the date of shipment. For units which are registered online at [www.eaton.com/PQ/Register](http://www.eaton.com/PQ/Register), the warranty is extended to thirty-six (36) months from the date of purchase, or forty-two (42) months from the date of shipment.

**WHAT THIS LIMITED WARRANTY COVERS:** The warrantor warrants that the Product and battery (individually and collectively, the "Warranted Items") are free from defects in material and workmanship. If, in the opinion of Company, a Warranted Item is defective and the defect is within the terms of this Warranty, Company's sole obligation will be to repair or replace such defective Warranted Item (including by providing service, parts and labor, as applicable), at the option of Company.

**PROCEDURES FOR REPAIR OR REPLACEMENT OF WARRANTED ITEMS:** The Warranted Item will be repaired or replaced at a Company site or such other location as determined by Company.

If the Warranted Item is to be replaced by Company, and the End-User supplies a credit card number or purchase order for the value of the replacement Product, Company will use commercially reasonable business efforts to ship (via standard ground shipment and at no cost to the End-User) the replacement Warranted Item to the End-User within one (1) business day after Company receives notice of the warranty claim. In such case, the End-User must return (at Company's expense) the defective Warranted Item to Company in the same packaging as the replacement Warranted Item received by the End-User or as otherwise instructed by Company. If Company does not receive the defective Warranted Item, Company will either charge the End-User's credit card, or send the End-User an invoice (which the End-User agrees to pay), for the value of the replacement Product.

If the Warranted Item is to be replaced by Company, but the End-User is unwilling or unable to supply a credit card number or purchase order for the value of the replacement Product, Company will use commercially reasonable business efforts to ship (via standard ground shipment and at no cost to the End-User) the replacement Warranted Item to the End-User within one (1) business day after Company receives the defective Product from the End-User.

In any case, Company will provide shipping instructions and will pay its designated carrier for all shipping charges for return of defective equipment and replacement of Warranted Items. Any returned Warranted Item or parts that are replaced may be new or reconditioned. All Warranted Items returned to Company and all parts replaced by Company shall become the property of Company.

**WHAT THIS LIMITED WARRANTY DOES NOT COVER:** This Warranty does not cover any defects or damages caused by: (a) failure to properly store the Product before installation, including the charge of batteries no later than the date indicated on the packaging; (b) shipping and delivery of the Product if shipping is FOB Factory; (c) neglect, accident, abuse, misuse, misapplication, or incorrect installation; (d) repair or alteration not authorized in writing by Company personnel or performed by an authorized Company Customer Service Engineer or Agent; (e) improper testing, operation, maintenance, adjustment, or modification of any kind not authorized in writing by Company personnel or performed by an authorized Company Customer Service Engineer or Agent; or (f) use of the Product under other than normal operating conditions or in a manner inconsistent with the Product's labels or instructions.

This Warranty is not valid if the Product's serial numbers have been removed or are illegible. Any Warranted Items repaired or replaced pursuant to this Warranty will be warranted for the remaining portion of the original Warranty subject to all the terms thereof.

Company shall not be responsible for any charges for testing, checking, removal, or installation of Warranted Items.

**COMPANY DOES NOT WARRANT EQUIPMENT NOT MANUFACTURED BY COMPANY. IF PERMITTED BY THE APPLICABLE MANUFACTURER, COMPANY SHALL PASS THROUGH SUCH MANUFACTURER'S WARRANTIES TO END-USER.**

**COMPANY DOES NOT WARRANT SOFTWARE, INCLUDING SOFTWARE EMBEDDED IN PRODUCTS, THAT IS NOT CREATED BY COMPANY. WITHOUT LIMITING THE FOREGOING, COMPANY SPECIFICALLY DOES NOT WARRANT SOFTWARE (SUCH AS LINUX) THAT WAS CREATED USING AN "OPEN SOURCE" MODEL OR IS DISTRIBUTED PURSUANT TO AN OPEN SOURCE LICENSE.**

**THIS WARRANTY IS THE SOLE AND EXCLUSIVE WARRANTY OFFERED BY COMPANY WITH RESPECT TO THE PRODUCTS AND SERVICES AND, EXCEPT FOR SUCH FOREGOING WARRANTY COMPANY DISCLAIMS ALL OTHER WARRANTIES INCLUDING BUT NOT LIMITED TO ANY IMPLIED WARRANTIES OF MERCHANTABILITY, TITLE, NON-INFRINGEMENT, AND FITNESS FOR A PARTICULAR PURPOSE. CORRECTION OF NON-CONFORMITIES IN THE MANNER AND FOR THE PERIOD OF TIME PROVIDED ABOVE SHALL CONSTITUTE COMPANY'S SOLE LIABILITY AND END-USER'S EXCLUSIVE REMEDY FOR FAILURE OF COMPANY TO MEET ITS WARRANTY OBLIGATIONS, WHETHER CLAIMS OF THE END-USER ARE BASED IN CONTRACT, IN TORT (INCLUDING NEGLIGENCE OR STRICT LIABILITY), OR OTHERWISE.**

**LIMITATION OF LIABILITY:** The remedies of the End-User set forth herein are exclusive and are the sole remedies for any failure of Company to comply with its obligations hereunder. In no event shall Company be liable in contract, in tort (including negligence or strict liability) or otherwise for damage to property or equipment other than the Products, including loss of profits or revenue, loss of use of Products, loss of data, cost of capital, claims of customers of the End-User, or any special, indirect, incidental, or consequential damages whatsoever. The total cumulative liability of Company hereunder whether the claims are based in contract (including indemnity), in tort (including negligence or strict liability), or otherwise, shall not exceed the price of the Product on which such liability is based.

Company shall not be responsible for failure to provide service or parts due to causes beyond Company's reasonable control.

**END-USER'S OBLIGATIONS:** In order to receive the benefits of this Warranty, the End-User must use the Product in a normal way; follow the Product's user's guide; and protect against further damage to the Product if there is a covered defect.

**OTHER LIMITATIONS:** Company's obligations under this Warranty are expressly conditioned upon receipt by Company of all payments due to it (including interest charges, if any). During such time as Company has not received payment of any amount due to it for the Product, in accordance with the contract terms under which the Product is sold, Company shall have no obligation under this Warranty. Also during such time, the period of this Warranty shall continue to run and the expiration of this Warranty shall not be extended upon payment of any overdue or unpaid amounts.

**COSTS NOT RELATED TO WARRANTY:** The End-User shall be invoiced for, and shall pay for, all services not expressly provided for by the terms of this Warranty, including without limitation, site calls involving an inspection that determines no corrective maintenance is required. Any costs for replacement equipment, installation, materials, freight charges, travel expenses, or labor of Company representatives outside the terms of this Warranty will be borne by the End-User.

**OBTAINING WARRANTY SERVICE:** In the USA, call the Customer Reliability Center 7x24 at 800-356-5737. Outside of the USA, call your local Eaton product sales or service representative. For comments or questions about this Warranty, write to the Customer Quality Representative, 3301 Spring Forest Road, Raleigh, North Carolina 27616 USA.

## Load Protection Guarantee (US and Canada)

### Eaton UPS Models 3105, 5110, 5115, 5125, and 5130

**GUARANTOR:** The Guarantor for the load protection guaranty set forth herein is Eaton Corporation, an Ohio Corporation company ("Company").

**LIMITED GUARANTY:** This load protection guaranty (this "Guaranty") applies only to the original End-User (the "End-User") of any Eaton 3105, 5110, 5115, 5125, and 5130 Products (individually and collectively, the "Product") and cannot be transferred. This Guaranty applies even in the event that the Product is initially sold by Company for resale to an End-User.

**WHAT THIS GUARANTY COVERS:** For the lifetime of the Product, Guarantor promises to repair or replace, at Guarantor's option, the equipment (valued up to the limits shown below\*) that is damaged by an AC power line surge, spike, or other transient when properly connected to Guarantor's uninterruptible power system ("UPS"). Reimbursement for or restoration of data loss excluded. This Guaranty applies only if all of the following circumstances arise:

1. The UPS is plugged into properly grounded and wired outlets, using no extension cords, adapters, other ground wires, or other electrical connectors;
2. The installation of the UPS complies with all applicable electrical and safety codes described by the National Electrical Code® (NEC®);
3. The UPS was used under normal operating conditions and in accordance with all labels and instructions; and
4. The UPS was not damaged by accident (other than AC power line transient), misuse, or abuse.

**\*Cumulative Limits to be paid by Guarantor under this Load Protection Guaranty:**

- \$25,000 for Eaton UPS Model 3105
- \$150,000 for Eaton UPS Models 5110, 5115, 5125, and 5130

## WARRANTY

**WHAT THIS GUARANTY DOES NOT COVER:** Any reimbursement or repair to End-User's equipment does not include reimbursement for or restoration of any data loss. This Guaranty does not cover any defects or damages caused by: (a) failure to properly store the Product before installation, including the charge of batteries no later than the date indicated on the packaging; (b) shipping and delivery of the Product if shipping is FOB Factory; (c) neglect, accident, abuse, misuse, misapplication, or incorrect installation of Product; (d) repair or alteration of Product not authorized in writing by Company personnel or performed by an authorized Company Customer Service Engineer or Agent; (e) improper testing, operation, maintenance, adjustment, or modification of any kind to the Product not authorized in writing by Company personnel or performed by an authorized Company Customer Service Engineer or Agent; or (f) use of the Product under other than normal operating conditions or in a manner inconsistent with the Product's labels or instructions.

**This Guaranty is not valid: (a) unless the End-User returns to Company the Warranty Registration Card or completes the registration form on [www.eaton.com/PQ/Register](http://www.eaton.com/PQ/Register) within thirty (30) days of purchase; or (b) if the Product's serial numbers have been removed or are illegible.**

Company shall not be responsible for any charges for testing, checking, removal, or installation of any items.

**LIMITATION OF LIABILITY:** THE REMEDIES OF THE END-USER SET FORTH HEREIN ARE EXCLUSIVE AND ARE THE SOLE REMEDIES FOR ANY FAILURE OF COMPANY TO COMPLY WITH ITS OBLIGATIONS HEREUNDER. EXCEPT AS OTHERWISE PROVIDED FOR IN THIS GUARANTY, IN NO EVENT SHALL COMPANY BE LIABLE IN CONTRACT, IN TORT (INCLUDING NEGLIGENCE OR STRICT LIABILITY), OR OTHERWISE FOR DAMAGE TO PROPERTY OR EQUIPMENT OTHER THAN THE PRODUCTS, INCLUDING LOSS OF PROFITS OR REVENUE, LOSS OF USE OF PRODUCTS, LOSS OF DATA, COST OF CAPITAL, CLAIMS OF CUSTOMERS OF THE END-USER OR ANY SPECIAL, INDIRECT, INCIDENTAL, OR CONSEQUENTIAL DAMAGES WHATSOEVER. THE TOTAL CUMULATIVE LIABILITY OF COMPANY HEREUNDER WHETHER THE CLAIMS ARE BASED IN CONTRACT (INCLUDING INDEMNITY), IN TORT (INCLUDING NEGLIGENCE OR STRICT LIABILITY), OR OTHERWISE, SHALL NOT EXCEED THOSE SET FORTH ABOVE.

Company shall not be responsible for failure to provide repair or replacement under this Guaranty due to causes beyond Company's reasonable control.

**END-USER'S OBLIGATIONS:** In order to receive the benefits of this Guaranty, the End-User must use the Product in a normal way; follow the Product's user's guide; and protect against further damage to the Product if there is a covered defect.

**OTHER LIMITATIONS:** Company's obligations under this Guaranty are expressly conditioned upon receipt by Company of all payments due to it (including interest charges, if any). During such time as Company has not received payment of any amount due to it for the Product, in accordance with the contract terms under which the Product is sold, Company shall have no obligation under this Guaranty.

**COSTS NOT RELATED TO GUARANTY:** The End-User shall be invoiced for, and shall pay for, all services not expressly provided for by the terms of this Guaranty, including without limitation, site calls involving an inspection that determines no corrective maintenance is required. Any costs for replacement equipment, installation, materials, freight charges, travel expenses, or labor of Company representatives outside the terms of this Guaranty will be borne by the End-User.

**TO MAKE A CLAIM:** In the USA, call the Customer Reliability Center 7x24 at 800-356-5737. Outside of the USA, contact your local Eaton product sales or service representative. For comments or questions about this Load Protection Guaranty, write to the Customer Quality Representative, 3301 Spring Forest Road, Raleigh, North Carolina 27616 USA.